

CENTURY 21 Catalog



SIGN COMPANY

A DIVISION OF LOWEN CORPORATION

800-545-5505

lowensign.com/century21

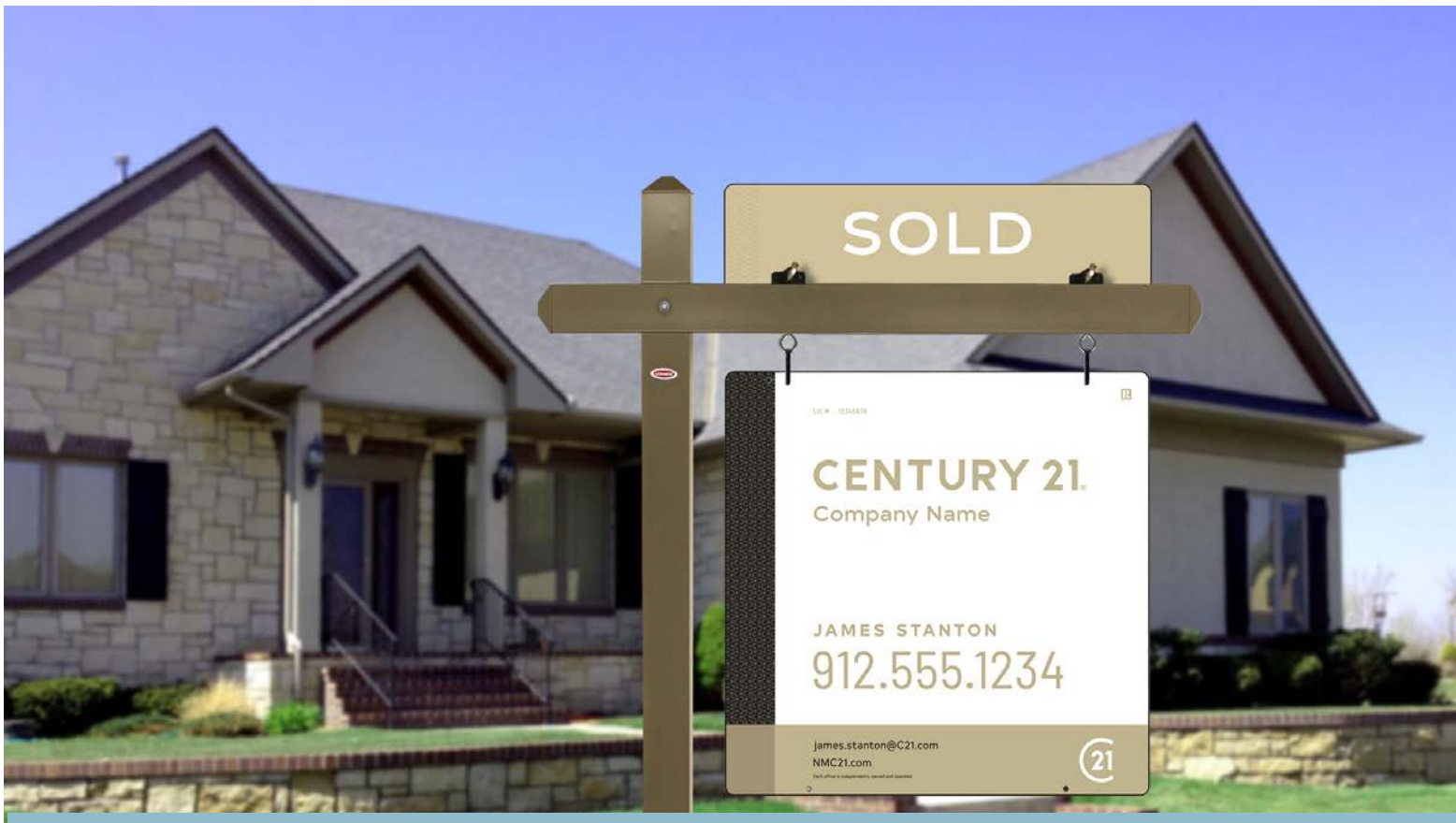

WHAT YOU GET WHEN YOU WORK WITH LOWEN SIGN COMPANY

We know you're busy. That's why Lowen Sign Company is continuously improving the products and services we provide. Order tracking and management tools at lowensign.com make it easy to reorder your yard signs and see what orders are on the way. You can even order signage on-the-go with your mobile device!

This hassle free experience is made even better with the fastest production time in the industry. Once you approve your order, signs are produced in just 3 days. They're then shipped promptly with tracking info provided in your lowensign.com account.

"I HAD CALLED ANOTHER COMPANY FOR A QUOTE BEFORE ORDERING FROM LOWEN. THEY WERE HIGHER IN PRICE AND WANTED TO CHARGE ME MORE BECAUSE I WAS CONCERNED ABOUT THE DELIVERY TIME. I WENT ONLINE AT LOWEN AND BEFORE I PUSHED SEND, I CALLED IN AND GOT A CUSTOMER SERVICE REPRESENTATIVE. SHE WALKED ME THROUGH THINGS AND HELPED TO EXPEDITE MY ORDER WHICH WENT OUT IN RECORD TIME."

- SUSAN FIKE



SUPERIOR MATERIALS

Advanced printing technology ensures a beautiful sign with a message that will last. All steel panels and frames are manufactured by us and are sealed with a powder coat for durability and longevity. We pride ourselves on overseeing the details of our products from start to finish.



FAST PRODUCTION TIME

Our 3 day production time is the fastest in the industry!

We've advanced our art systems, invested in the newest printing technology, and expanded our work force to achieve a 3 Day Production Program. This program ensures sign delivery in record time. Your order is produced and ready to ship just 3 days after order approval.



CUSTOMER SERVICE

When you call Lowen, a real person answers the phone every time. There's no automated voice system here. Our friendly and knowledgeable representatives make sure you get the perfect signage for your professional real estate needs.



WEBSITE FEATURES

We've worked hard to make our website mobile friendly. That means it's easy to order signs on-the-go from your phone or tablet. The biggest advantage to our website are the account features such as Order History and Shipment Tracking.



CENTRALLY LOCATED

All of our signage and frames are made in the U.S.A.! We manufacture our products from raw materials at our headquarters in Hutchinson, Kansas. Because of our central location in the heart of America, we have the advantage of fast delivery to anywhere in the country.

LOWENSIGN.COM

Leave the cluttered, confusing, online ordering experience behind.



1

ACCESS FROM YOUR TABLET OR MOBILE FOR ON-THE-GO ORDERING.

2

ORDER HISTORY FOR ONE CLICK REORDERING OF YOUR FAVORITE PRODUCTS.

3

KNOW WHEN TO EXPECT YOUR ORDER WITH SHIPMENT TRACKING.

4

EASILY CUSTOMIZE YOUR REAL ESTATE SIGNAGE.

18 X 24 SIGN UNITS – PANEL & FRAME ASSEMBLED



18 X 24 ROUND ROD UNITS

24 Ga Steel Panel Units

ITEM	STYLE	3	5	10	15	25	50	100	
21Z902	Agent Unit	A / B	43.00	34.05	31.60	30.80	30.00	29.85	29.75
21Z902-OP	Office Unit	A / B	43.00	34.05	31.60	30.80	30.00	29.85	29.75
21Z903	Agent Unit	C / D	43.00	34.05	31.60	30.80	30.00	29.85	29.75
21Z903-OP	Office Unit	C / D	43.00	34.05	31.60	30.80	30.00	29.85	29.75
21Z903W	Agent - White Frame	B / D	43.00	34.05	31.60	30.80	30.00	29.85	29.75
21Z903W-OP	Office - White Frame	B / D	43.00	34.05	31.60	30.80	30.00	29.85	29.75

Aluminum Panel Units

21A902	Agent Unit	A / B	45.15	35.85	33.30	32.55	31.95	31.55	31.50
21A902-OP	Office Unit	A / B	45.15	35.85	33.30	32.55	31.95	31.55	31.50
21A903	Agent Unit	C / D	45.15	35.85	33.30	32.55	31.95	31.55	31.50
21A903-OP	Office Unit	C / D	45.15	35.85	33.30	32.55	31.95	31.55	31.50
21A903W	Agent - White Frame	B / D	45.15	35.85	33.30	32.55	31.95	31.55	31.50
21A903W-OP	Office - White Frame	B / D	45.15	35.85	33.30	32.55	31.95	31.55	31.50

Aluminum Composite Panel Units

21L902	Agent Unit	A / B	45.95	36.85	34.35	33.40	32.90	32.60	32.55
21L902-OP	Office Unit	A / B	45.95	36.85	34.35	33.40	32.90	32.60	32.55
21L903	Agent Unit	C / D	45.95	36.85	34.35	33.40	32.90	32.60	32.55
21L903-OP	Office Unit	C / D	45.95	36.85	34.35	33.40	32.90	32.60	32.55
21L903W	Agent - White Frame	B / D	45.95	36.85	34.35	33.40	32.90	32.60	32.55
21L903W-OP	Office - White Frame	B / D	45.95	36.85	34.35	33.40	32.90	32.60	32.55

Price each.

18 X 24 ANGLE IRON WITH 2 RIDER INSERT UNITS

24 Ga Steel Panel Units

ITEM	STYLE	3	5	10	15	25	50	100	
21Z940	Agent Unit	A / B	52.05	42.35	37.20	35.50	34.10	33.95	33.30
21Z940-OP	Office Unit	A / B	52.05	42.35	37.20	35.50	34.10	33.95	33.30
21Z941	Agent Unit	C / D	52.05	42.35	37.20	35.50	34.10	33.95	33.30
21Z941-OP	Office Unit	C / D	52.05	42.35	37.20	35.50	34.10	33.95	33.30
21Z941W	Agent - White Frame	B / D	52.05	42.35	37.20	35.50	34.10	33.95	33.30
21Z941W-OP	Office - White Frame	B / D	52.05	42.35	37.20	35.50	34.10	33.95	33.30

Aluminum Panel Units

21A940	Agent Unit	A / B	54.25	44.10	39.05	38.15	37.35	35.05	34.80
21A940-OP	Office Unit	A / B	54.25	44.10	39.05	38.15	37.35	35.05	34.80
21A940	Agent Unit	C / D	54.25	44.10	39.05	38.15	37.35	35.05	34.80
21A940-OP	Office Unit	C / D	54.25	44.10	39.05	38.15	37.35	35.05	34.80
21A940W	Agent - White Frame	B / D	54.25	44.10	39.05	38.15	37.35	35.05	34.80
21A940W-OP	Office - White Frame	B / D	54.25	44.10	39.05	38.15	37.35	35.05	34.80

Aluminum Composite Panel Units

21L940	Agent Unit	A / B	55.10	45.25	40.25	39.10	38.35	36.10	35.85
21L940-OP	Office Unit	A / B	55.10	45.25	40.25	39.10	38.35	36.10	35.85
21L940	Agent Unit	C / D	55.10	45.25	40.25	39.10	38.35	36.10	35.85
21L940-OP	Office Unit	C / D	55.10	45.25	40.25	39.10	38.35	36.10	35.85
21L940W	Agent - White Frame	B / D	55.10	45.25	40.25	39.10	38.35	36.10	35.85
21L940W-OP	Office - White Frame	B / D	55.10	45.25	40.25	39.10	38.35	36.10	35.85

Price each.

18 X 24 SIGN PANELS

18 X 24 REPLACEMENT PANELS FOR FRAMES

24 Ga Steel Panels

ITEM	STYLE	3	5	10	15	25	50	100
21Z843	Agent Panel-C / D	20.80	15.85	12.50	11.95	10.95	10.40	10.10
21Z843-OP	Office Panel-C / D	20.80	15.85	12.50	11.95	10.95	10.40	10.10
21Z851	Agent Panel-A / B	20.80	15.85	12.50	11.95	10.95	10.40	10.10
21Z851-OP	Office Panel-A / B	20.80	15.85	12.50	11.95	10.95	10.40	10.10

Aluminum Panels

21A843	Agent Panel-C / D	32.25	22.25	17.40	16.55	14.55	13.80	13.45
21A843-OP	Office Panel-C / D	32.25	22.25	17.40	16.55	14.55	13.80	13.45
21A851	Agent Panel-A / B	32.25	22.25	17.40	16.55	14.55	13.80	13.45
21A851-OP	Office Panel-A / B	32.25	22.25	17.40	16.55	14.55	13.80	13.45

Aluminum Composite Panels

21L843	Agent Panel-C / D	25.50	19.95	16.90	15.50	13.60	13.25	12.60
21L843-OP	Office Panel-C / D	25.50	19.95	16.90	15.50	13.60	13.25	12.60
21L851	Agent Panel-A / B	25.50	19.95	16.90	15.50	13.60	13.25	12.60
21L851-OP	Office Panel-A / B	25.50	19.95	16.90	15.50	13.60	13.25	12.60

Steel Reflective Panels

21Z843R	Agent Panel-C / D	37.10	30.30	26.20	25.80	24.20	23.55	23.35
21Z843R-OP	Office Panel-C / D	37.10	30.30	26.20	25.80	24.20	23.55	23.35

Aluminum Composite Reflective Panels

21L843R	Agent Panel-C / D	36.95	31.05	27.30	25.90	24.35	23.70	23.05
21L843R-OP	Office Panel-C / D	36.95	31.05	27.30	25.90	24.35	23.70	23.05
21L851R	Agent Panel-A / B	36.95	31.05	27.30	25.90	24.35	23.70	23.05
21L851R-OP	Office Panel-A / B	36.95	31.05	27.30	25.90	24.35	23.70	23.05

Price each.

18 X 24 HANGING PANELS

24 Ga Steel Panels

ITEM		3	5	10	15	25	50	100
21Z848	Agent Panel-C / D	24.65	18.65	15.10	14.80	13.30	12.65	12.40
21Z848-OP	Office Panel-C / D	24.65	18.65	15.10	14.80	13.30	12.65	12.40
21Z850	Agent Panel-E / F	24.65	18.65	15.10	14.80	13.30	12.65	12.40
21Z850-OP	Office Panel-E / F	24.65	18.65	15.10	14.80	13.30	12.65	12.40
21Z853	Agent Panel-A / B	24.65	18.65	15.10	14.80	13.30	12.65	12.40
21Z853-OP	Office Panel-A / B	24.65	18.65	15.10	14.80	13.30	12.65	12.40

Aluminum Panels

21A848	Agent Panel-C / D	27.70	23.25	17.20	16.40	15.10	14.40	14.10
21A848-OP	Office Panel-C / D	27.70	23.25	17.20	16.40	15.10	14.40	14.10
21A850	Agent Panel-E / F	27.70	23.25	17.20	16.40	15.10	14.40	14.10
21A850-OP	Office Panel-E / F	27.70	23.25	17.20	16.40	15.10	14.40	14.10
21A853	Agent Panel-A / B	27.70	23.25	17.20	16.40	15.10	14.40	14.10
21A853-OP	Office Panel-A / B	27.70	23.25	17.20	16.40	15.10	14.40	14.10

Aluminum Composite Panels

21L848	Agent Panel-C / D	26.55	20.85	17.30	16.25	14.65	14.30	13.35
21L848-OP	Office Panel-C / D	26.55	20.85	17.30	16.25	14.65	14.30	13.35
21L850	Agent Panel-E / F	26.55	20.85	17.30	16.25	14.65	14.30	13.35
21L850-OP	Office Panel-E / F	26.55	20.85	17.30	16.25	14.65	14.30	13.35
21L853	Agent Panel-A / B	26.55	20.85	17.30	16.25	14.65	14.30	13.35
21L853-OP	Office Panel-A / B	26.55	20.85	17.30	16.25	14.65	14.30	13.35

Aluminum Composite Reflective Panels

21L848R	Agent Panel-C / D	37.10	31.55	27.70	26.85	25.10	24.60	23.80
21L848R-OP	Office Panel-C / D	37.10	31.55	27.70	26.85	25.10	24.60	23.80
21L850R	Agent Panel-E / F	37.10	31.55	27.70	26.85	25.10	24.60	23.80
21L850R-OP	Office Panel-E / F	37.10	31.55	27.70	26.85	25.10	24.60	23.80
21L853R	Agent Panel-A / B	37.10	31.55	27.70	26.85	25.10	24.60	23.80
21L853R-OP	Office Panel-A / B	37.10	31.55	27.70	26.85	25.10	24.60	23.80

Price each.

18 x 24 Agent Panel Styles

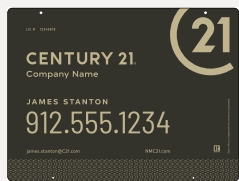

A - SEAL - BLACK



B - SEAL - WHITE

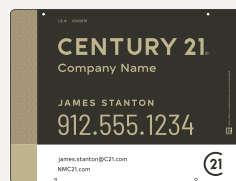

C - MOSAIC - BLACK



D - MOSAIC - WHITE

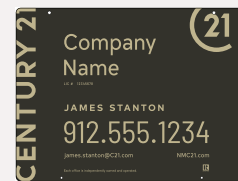

E - WORDMARK - BLACK



F - WORDMARK - WHITE

18 x 24 Office Panel Styles

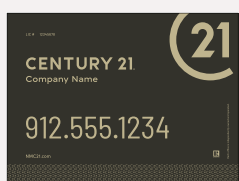

A - SEAL - BLACK



B - SEAL - WHITE



C - MOSAIC - BLACK



D - MOSAIC - WHITE



E - WORDMARK - BLACK



F - WORDMARK - WHITE

22 X 24 SIGN UNITS – PANEL & FRAME ASSEMBLED



22 X 24 ANGLE IRON UNITS

24 Ga Steel Panel Units

ITEM	STYLE	3	5	10	15	25	50	100	
21Z961	Agent Unit	C / D	50.25	40.80	37.50	35.90	34.70	34.35	33.95
21Z961-OP	Office Unit	C / D	50.25	40.80	37.50	35.90	34.70	34.35	33.95
21Z963	Agent Unit	A / B	50.25	40.80	37.50	35.90	34.70	34.35	33.95
21Z963-OP	Office Unit	A / B	50.25	40.80	37.50	35.90	34.70	34.35	33.95
21Z961W	Agent - White Frame	C / D	50.25	40.80	37.50	35.90	34.70	34.35	33.95
21Z961W-OP	Office - White Frame	C / D	50.25	40.80	37.50	35.90	34.70	34.35	33.95

Aluminum Panel Units

21A961	Agent Unit	C / D	56.00	46.30	42.90	41.40	40.95	39.95	39.70
21A961-OP	Office Unit	C / D	56.00	46.30	42.90	41.40	40.95	39.95	39.70
21A963	Agent Unit	A / B	56.00	46.30	42.90	41.40	40.95	39.95	39.70
21A963-OP	Office Unit	A / B	56.00	46.30	42.90	41.40	40.95	39.95	39.70
21A961W	Agent - White Frame	C / D	56.00	46.30	42.90	41.40	40.95	39.95	39.70
21A961W-OP	Office - White Frame	C / D	56.00	46.30	42.90	41.40	40.95	39.95	39.70

Aluminum Composite Panel Units

21L961	Agent Unit	C / D	56.90	47.10	43.85	42.25	41.30	40.90	40.60
21L961-OP	Office Unit	C / D	56.90	47.10	43.85	42.25	41.30	40.90	40.60
21L963	Agent Unit	A / B	56.90	47.10	43.85	42.25	41.30	40.90	40.60
21L963-OP	Office Unit	A / B	56.90	47.10	43.85	42.25	41.30	40.90	40.60
21L961W	Agent - White Frame	C / D	56.90	47.10	43.85	42.25	41.30	40.90	40.60
21L961W-OP	Office - White Frame	C / D	56.90	47.10	43.85	42.25	41.30	40.90	40.60

Price each.

22 X 24 ANGLE IRON WITH 2 RIDER INSERT UNITS

24 Ga Steel Panel Units

ITEM	STYLE	3	5	10	15	25	50	100	
21Z964	Agent Unit	C / D	52.85	43.90	40.90	38.95	37.60	37.30	36.75
21Z964-OP	Office Unit	C / D	52.85	43.90	40.90	38.95	37.60	37.30	36.75
21Z966	Agent Unit	A / B	52.85	43.90	40.90	38.95	37.60	37.30	36.75
21Z966-OP	Office Unit	A / B	52.85	43.90	40.90	38.95	37.60	37.30	36.75

Aluminum Panel Units

21A964	Agent Unit	C / D	58.55	49.65	46.55	44.30	42.85	42.45	42.15
21A964-OP	Office Unit	C / D	58.55	49.65	46.55	44.30	42.85	42.45	42.15
21A966	Agent Unit	A / B	58.55	49.65	46.55	44.30	42.85	42.45	42.15
21A966-OP	Office Unit	A / B	58.55	49.65	46.55	44.30	42.85	42.45	42.15
21A964W	Agent - White Frame	C / D	58.55	49.65	46.55	44.30	42.85	42.45	42.15
21A964W-OP	Office - White Frame	C / D	58.55	49.65	46.55	44.30	42.85	42.45	42.15

Aluminum Composite Panel Units

21L964	Agent Unit	C / D	60.45	52.05	48.50	46.25	45.10	44.25	43.85
21L964-OP	Office Unit	C / D	60.45	52.05	48.50	46.25	45.10	44.25	43.85
21L966	Agent Unit	A / B	60.45	52.05	48.50	46.25	45.10	44.25	43.85
21L966-OP	Office Unit	A / B	60.45	52.05	48.50	46.25	45.10	44.25	43.85
21L964W	Agent - White Frame	C / D	60.45	52.05	48.50	46.25	45.10	44.25	43.85
21L964W-OP	Office - White Frame	C / D	60.45	52.05	48.50	46.25	45.10	44.25	43.85

Price each.

22 X 24 SIGN PANELS

22 X 24 REPLACEMENT PANELS FOR FRAMES

24 Ga Steel Panels

ITEM	STYLE	3	5	10	15	25	50	100
21Z854	Agent Panel-C / D	23.90	18.60	15.10	15.00	14.10	13.15	13.00
21Z854-OP	Office Panel-C / D	23.90	18.60	15.10	15.00	14.10	13.15	13.00
21Z856	Agent Panel-A / B	23.90	18.60	15.10	15.00	14.10	13.15	13.00
21Z856-OP	Office Panel-A / B	23.90	18.60	15.10	15.00	14.10	13.15	13.00

Aluminum Panels

21A854	Agent Panel-C / D	32.35	25.00	24.25	18.40	17.45	16.45	16.20
21A854-OP	Office Panel-C / D	32.35	25.00	24.25	18.40	17.45	16.45	16.20
21A856	Agent Panel-A / B	32.35	25.00	24.25	18.40	17.45	16.45	16.20
21A856-OP	Office Panel-A / B	32.35	25.00	24.25	18.40	17.45	16.45	16.20

Aluminum Composite Panels

21L854	Agent Panel-C / D	29.95	24.20	19.35	18.20	17.15	16.55	15.85
21L854-OP	Office Panel-C / D	29.95	24.20	19.35	18.20	17.15	16.55	15.85
21L856	Agent Panel-A / B	29.95	24.20	19.35	18.20	17.15	16.55	15.85
21L856-OP	Office Panel-A / B	29.95	24.20	19.35	18.20	17.15	16.55	15.85

Steel Reflective Panels

21Z854R	Agent Panel-C / D	43.70	38.00	32.75	31.65	30.60	29.85	29.75
21Z854R-OP	Office Panel-C / D	43.70	38.00	32.75	31.65	30.60	29.85	29.75
21Z856R	Agent Panel-A / B	43.70	38.00	32.75	31.65	30.60	29.85	29.75
21Z856R-OP	Office Panel-A / B	43.70	38.00	32.75	31.65	30.60	29.85	29.75

Aluminum Composite Reflective Panels

21L854R	Agent Panel-C / D	46.10	40.75	36.45	35.15	34.25	33.10	32.25
21L854R-OP	Office Panel-C / D	46.10	40.75	36.45	35.15	34.25	33.10	32.25
21L856R	Agent Panel-A / B	46.10	40.75	36.45	35.15	34.25	33.10	32.25
21L856R-OP	Office Panel-A / B	46.10	40.75	36.45	35.15	34.25	33.10	32.25

Price each.

22 X 24 HANGING PANELS

24 Ga Steel Panels

ITEM	STYLE	3	5	10	15	25	50	100
21Z862	Agent Panel-E / F	28.60	22.35	19.05	17.95	17.00	16.45	16.15
21Z862-OP	Office Panel-E / F	28.60	22.35	19.05	17.95	17.00	16.45	16.15
21Z863	Agent Panel-C / D	28.60	22.35	19.05	17.95	17.00	16.45	16.15
21Z863-OP	Office Panel-C / D	28.60	22.35	19.05	17.95	17.00	16.45	16.15
21Z865	Agent Panel-A / B	28.60	22.35	19.05	17.95	17.00	16.45	16.15
21Z865-OP	Office Panel-A / B	28.60	22.35	19.05	17.95	17.00	16.45	16.15

Aluminum Panels

21A862	Agent Panel-E / F	33.85	31.40	26.20	24.15	24.80	24.20	23.95
21A862-OP	Office Panel-E / F	33.85	31.40	26.20	24.15	24.80	24.20	23.95
21A863	Agent Panel-C / D	33.85	31.40	26.20	24.15	24.80	24.20	23.95
21A863-OP	Office Panel-C / D	33.85	31.40	26.20	24.15	24.80	24.20	23.95
21A865	Agent Panel-A / B	33.85	31.40	26.20	24.15	24.80	24.20	23.95
21A865-OP	Office Panel-A / B	33.85	31.40	26.20	24.15	24.80	24.20	23.95

Aluminum Composite Panels

21L863	Agent Panel-C / D	30.20	24.40	19.55	19.05	18.20	17.55	16.60
21L863-OP	Office Panel-C / D	30.20	24.40	19.55	19.05	18.20	17.55	16.60
21L865	Agent Panel-A / B	30.20	24.40	19.55	19.05	18.20	17.55	16.60
21L865-OP	Office Panel-A / B	30.20	24.40	19.55	19.05	18.20	17.55	16.60

Aluminum Composite Reflective Panels

21L862R	Agent Panel-E / F	47.45	41.65	37.10	36.20	34.40	33.70	33.15
21L862R-OP	Office Panel-E / F	47.45	41.65	37.10	36.20	34.40	33.70	33.15
21L863R	Agent Panel-C / D	47.45	41.65	37.10	36.20	34.40	33.70	33.15
21L863R-OP	Office Panel-C / D	47.45	41.65	37.10	36.20	34.40	33.70	33.15
21L865R	Agent Panel-A / B	47.45	41.65	37.10	36.20	34.40	33.70	33.15
21L865R-OP	Office Panel-A / B	47.45	41.65	37.10	36.20	34.40	33.70	33.15

Price each.

22 x 24 Agent Panels



A - SEAL - BLACK



B - SEAL - WHITE

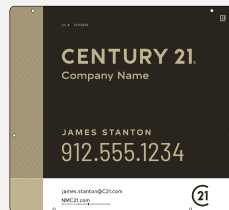

C - MOSAIC - BLACK



D - MOSAIC - WHITE



E - WORDMARK - BLACK



F - WORDMARK - WHITE

22 x 24 Office Panels



A - SEAL - BLACK



B - SEAL - WHITE



C - MOSAIC - BLACK

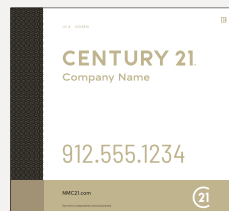

D - MOSAIC - WHITE



E - WORDMARK - BLACK



F - WORDMARK - WHITE

24 X 24 SIGN UNITS – PANEL & FRAME ASSEMBLED



24 X 24 ANGLE IRON UNITS

24 Ga Steel Panel Units

ITEM	STYLE	3	5	10	15	25	50	100	
21Z927	Agent Unit	C / D	55.05	49.80	45.95	38.90	38.20	37.05	36.25
21Z927-OP	Office Unit	C / D	55.05	49.80	45.95	38.90	38.20	37.05	36.25
21Z928	Agent Unit	A / B	55.05	49.80	45.95	38.90	38.20	37.05	36.25
21Z928-OP	Office Unit	A / B	55.05	49.80	45.95	38.90	38.20	37.05	36.25
21Z928W	Agent - White Frame	B / D	55.05	49.80	45.95	38.90	38.20	37.05	36.25
21Z928W-OP	Office - White Frame	B / D	55.05	49.80	45.95	38.90	38.20	37.05	36.25

Aluminum Panel Units

12A927	Agent Unit	C / D	66.00	54.35	46.85	43.85	41.85	41.30	40.70
21A927-OP	Office Unit	C / D	66.00	54.35	46.85	43.85	41.85	41.30	40.70
21A928	Agent Unit	A / B	66.00	54.35	46.85	43.85	41.85	41.30	40.70
21A928-OP	Office Unit	A / B	66.00	54.35	46.85	43.85	41.85	41.30	40.70
21A928W	Agent - White Frame	B / D	66.00	54.35	46.85	43.85	41.85	41.30	40.70
21A928W-OP	Office - White Frame	B / D	66.00	54.35	46.85	43.85	41.85	41.30	40.70

Aluminum Composite Panel Units

21L927	Agent Unit	C / D	64.60	58.10	49.60	45.35	44.50	43.90	43.55
21L927-OP	Office Unit	C / D	64.60	58.10	49.60	45.35	44.50	43.90	43.55
21L928	Agent Unit	A / B	64.60	58.10	49.60	45.35	44.50	43.90	43.55
21L928-OP	Office Unit	A / B	64.60	58.10	49.60	45.35	44.50	43.90	43.55
21L928W	Agent - White Frame	B / D	64.60	58.10	49.60	45.35	44.50	43.90	43.55
21L928W-OP	Office - White Frame	B / D	64.60	58.10	49.60	45.35	44.50	43.90	43.55

Price each.

24 X 24 ANGLE IRON WITH 2 RIDER INSERT UNITS

24 Ga Steel Panel Units

ITEM	STYLE	3	5	10	15	25	50	100	
21Z938	Agent Unit	C / D	60.40	50.80	47.30	46.50	44.50	42.10	38.15
21Z938-OP	Office Unit	C / D	60.40	50.80	47.30	46.50	44.50	42.10	38.15
21Z939	Agent Unit	A / B	60.40	50.80	47.30	46.50	44.50	42.10	38.15
21Z939-OP	Office Unit	A / B	60.40	50.80	47.30	46.50	44.50	42.10	38.15
21Z938W	Agent - White Frame	B / D	60.40	50.80	47.30	46.50	44.50	42.10	38.15
21Z938W-OP	Office - White Frame	B / D	60.40	50.80	47.30	46.50	44.50	42.10	38.15

Aluminum Panel Units

21A938	Agent Unit	C / D	63.60	55.05	49.40	47.90	46.55	43.65	39.55
21A938-OP	Office Unit	C / D	63.60	55.05	49.40	47.90	46.55	43.65	39.55
21A939	Agent Unit	A / B	63.60	55.05	49.40	47.90	46.55	43.65	39.55
21A939-OP	Office Unit	A / B	63.60	55.05	49.40	47.90	46.55	43.65	39.55
21A938W	Agent - White Frame	B / D	63.60	55.05	49.40	47.90	46.55	43.65	39.55
21A938W-OP	Office - White Frame	B / D	63.60	55.05	49.40	47.90	46.55	43.65	39.55

Aluminum Composite Panel Units

21L938	Agent Unit	C / D	64.95	59.25	54.90	54.25	49.60	48.95	48.55
21L938-OP	Office Unit	C / D	64.95	59.25	54.90	54.25	49.60	48.95	48.55
21L939	Agent Unit	A / B	64.95	59.25	54.90	54.25	49.60	48.95	48.55
21L939-OP	Office Unit	A / B	64.95	59.25	54.90	54.25	49.60	48.95	48.55
21L938W	Agent - White Frame	B / D	64.95	59.25	54.90	54.25	49.60	48.95	48.55
21L938W-OP	Office - White Frame	B / D	64.95	59.25	54.90	54.25	49.60	48.95	48.55

24 X 24 REPLACEMENT PANELS FOR FRAMES

24 Ga Steel Panels

ITEM	STYLE	3	5	10	15	25	50	100
21Z871	Agent Panel-C / D	25.25	20.45	18.05	17.80	16.85	16.45	16.10
21Z871-OP	Office Panel-C / D	25.25	20.45	18.05	17.80	16.85	16.45	16.10
21Z872	Agent Panel-A / B	25.25	20.45	18.05	17.80	16.85	16.45	16.10
21Z872-OP	Office Panel-A / B	25.25	20.45	18.05	17.80	16.85	16.45	16.10

Aluminum Panels

21A871	Agent Panel-C / D	35.40	27.70	24.75	21.20	20.00	19.25	18.90
21A871-OP	Office Panel-C / D	35.40	27.70	24.75	21.20	20.00	19.25	18.90
21A872	Agent Panel-A / B	35.40	27.70	24.75	21.20	20.00	19.25	18.90
21A872-OP	Office Panel-A / B	35.40	27.70	24.75	21.20	20.00	19.25	18.90

Aluminum Composite Panels

21L871	Agent Panel-C / D	32.45	27.15	21.30	20.50	19.70	19.10	18.35
21L871-OP	Office Panel-C / D	32.45	27.15	21.30	20.50	19.70	19.10	18.35
21L872	Agent Panel-A / B	32.45	27.15	21.30	20.50	19.70	19.10	18.35
21L872-OP	Office Panel-A / B	32.45	27.15	21.30	20.50	19.70	19.10	18.35

Steel Reflective Panels

21Z871R	Agent Panel-C / D	46.20	40.65	37.70	35.05	34.05	33.55	33.15
21Z871R-OP	Office Panel-C / D	46.20	40.65	37.70	35.05	34.05	33.55	33.15
21Z872R	Agent Panel-A / B	46.20	40.65	37.70	35.05	34.05	33.55	33.15
21Z872R-OP	Office Panel-A / B	46.20	40.65	37.70	35.05	34.05	33.55	33.15

Aluminum Composite Reflective Panels

21L871R	Agent Panel-C / D	49.75	44.20	40.80	40.55	39.35	38.85	38.45
21L871R-OP	Office Panel-C / D	49.75	44.20	40.80	40.55	39.35	38.85	38.45
21L872R	Agent Panel-A / B	49.75	44.20	40.80	40.55	39.35	38.85	38.45
21L872R-OP	Office Panel-A / B	49.75	44.20	40.80	40.55	39.35	38.85	38.45

Price each.

24 X 24 HANGING PANELS

24 Ga Steel Panels

ITEM	STYLE	3	5	10	15	25	50	100
21871H-OP	Agent Panel-C / D	30.10	25.15	22.35	21.15	20.30	19.35	19.15
21Z871H-OP	Office Panel-C / D	30.10	25.15	22.35	21.15	20.30	19.35	19.15
21Z872H	Agent Panel-A / B	30.10	25.15	22.35	21.15	20.30	19.35	19.15
21Z872H-OP	Office Panel-A / B	30.10	25.15	22.35	21.15	20.30	19.35	19.15
21Z875H	Agent Panel-E / F	30.10	25.15	22.35	21.15	20.30	19.35	19.15
21Z875H-OP	Office Panel-E / F	30.10	25.15	22.35	21.15	20.30	19.35	19.15

Aluminum Panels

21A871H	Agent Panel-C / D	34.95	32.35	27.25	26.50	25.90	25.40	25.10
21A871H-OP	Office Panel-C / D	34.95	32.35	27.25	26.50	25.90	25.40	25.10
21A872H	Agent Panel-A / B	34.95	32.35	27.25	26.50	25.90	25.40	25.10
21A872H-OP	Office Panel-A / B	34.95	32.35	27.25	26.50	25.90	25.40	25.10
21A875H	Agent Panel-E / F	34.95	32.35	27.25	26.50	25.90	25.40	25.10
21A875H-OP	Office Panel-E / F	34.95	32.35	27.25	26.50	25.90	25.40	25.10

Aluminum Composite Panels

21L871H	Agent Panel-C / D	32.95	27.25	23.40	22.70	21.25	20.10	19.25
21L871H-OP	Office Panel-C / D	32.95	27.25	23.40	22.70	21.25	20.10	19.25
21L872H	Agent Panel-A / B	32.95	27.25	23.40	22.70	21.25	20.10	19.25
21L872H-OP	Office Panel-A / B	32.95	27.25	23.40	22.70	21.25	20.10	19.25
21L875H	Agent Panel-E / F	32.95	27.25	23.40	22.70	21.25	20.10	19.25
21L875H-OP	Office Panel-E / F	32.95	27.25	23.40	22.70	21.25	20.10	19.25

Aluminum Composite Reflective Panels

21L871RH	Agent Panel-C / D	53.50	47.60	42.30	40.95	39.75	38.90	38.65
21L871RH-OP	Office Panel-C / D	53.50	47.60	42.30	40.95	39.75	38.90	38.65
21L872RH	Agent Panel-A / B	53.50	47.60	42.30	40.95	39.75	38.90	38.65
21L872RH-OP	Office Panel-A / B	53.50	47.60	42.30	40.95	39.75	38.90	38.65
21L865R	Agent Panel-E / F	53.50	47.60	42.30	40.95	39.75	38.90	38.65
21L875RH-OP	Office Panel-E / F	53.50	47.60	42.30	40.95	39.75	38.90	38.65

Price each.

24 x 24 Agent Panels



A - SEAL - BLACK



B - SEAL - WHITE



C - MOSAIC - BLACK



D - MOSAIC - WHITE



E - WORDMARK - BLACK



F - WORDMARK - WHITE

24 x 24 Office Panels



A - SEAL - BLACK



B - SEAL - WHITE

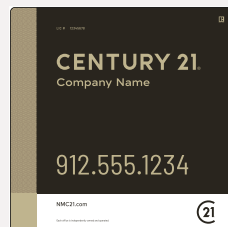

C - MOSAIC - BLACK

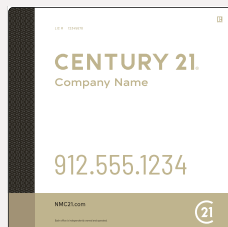

D - MOSAIC - WHITE



E - WORDMARK - BLACK



F - WORDMARK - WHITE

30X24 SIGNS – PANEL & FRAME ASSEMBLED



30X24 ANGLE IRON UNITS

24 Ga Steel Panel Units

ITEM	STYLE	3	5	10	15	25	50	100	
21Z973	Agent Unit	A / B	76.10	58.40	46.80	42.00	39.25	39.10	38.80
21Z973-OP	Office Unit	A / B	76.10	58.40	46.80	42.00	39.25	39.10	38.80
21Z974	Agent Unit	C / D	76.10	58.40	46.80	42.00	39.25	39.10	38.80
21Z974-OP	Office Unit	C / D	76.10	58.40	46.80	42.00	39.25	39.10	38.80
21Z974W	Agent - White Frame	B / D	76.10	58.40	46.80	42.00	39.25	39.10	38.80
21Z974W-OP	Office - White Frame	B / D	76.10	58.40	46.80	42.00	39.25	39.10	38.80
21Z980	Office/Agent Unit	G / H	76.10	58.40	46.80	42.00	39.25	39.10	38.80
21Z981	Office/Agent Unit	I / J	76.10	58.40	46.80	42.00	39.25	39.10	38.80
21Z980W	O/A White Frame	B	76.10	58.40	46.80	42.00	39.25	39.10	38.80

Aluminum Panel Units

21A973-OP	Office Unit	C / D	82.00	63.65	52.30	47.65	44.80	44.60	44.20
21A974	Agent Unit	A / B	82.00	63.65	52.30	47.65	44.80	44.60	44.20
21A974-OP	Office Unit	A / B	82.00	63.65	52.30	47.65	44.80	44.60	44.20
21A974W	Agent - White Frame	B / D	82.00	63.65	52.30	47.65	44.80	44.60	44.20
21A974W-OP	Office - White Frame	B / D	82.00	63.65	52.30	47.65	44.80	44.60	44.20
21A980	Office/Agent Unit	G / H	82.00	63.65	52.30	47.65	44.80	44.60	44.20
21A981	Office/Agent Unit	I / J	82.00	63.65	52.30	47.65	44.80	44.60	44.20
21A980W	O/A White Frame	B	82.00	63.65	52.30	47.65	44.80	44.60	44.20

Aluminum Composite Panel Units

21L973	Agent Unit	A / B	83.60	65.70	54.50	49.40	47.05	46.25	45.85
21L973-OP	Office Unit	A / B	83.60	65.70	54.50	49.40	47.05	46.25	45.85
21L974	Agent Unit	C / D	83.60	65.70	54.50	49.40	47.05	46.25	45.85
21L974-OP	Office Unit	C / D	83.60	65.70	54.50	49.40	47.05	46.25	45.85
21L974W	Agent - White Frame	B / D	83.60	65.70	54.50	49.40	47.05	46.25	45.85
21L974W-OP	Office - White Frame	B / D	83.60	65.70	54.50	49.40	47.05	46.25	45.85
21L980	Office/Agent Unit	G / H	83.60	65.70	54.50	49.40	47.05	46.25	45.85
21L981	Office/Agent Unit	I / J	83.60	65.70	54.50	49.40	47.05	46.25	45.85
21L980W	O/A White Frame	B	83.60	65.70	54.50	49.40	47.05	46.25	45.85

Price each.

30X24 OFFICE/AGENT PANELS

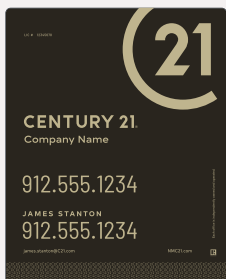

G - SEAL - BLACK

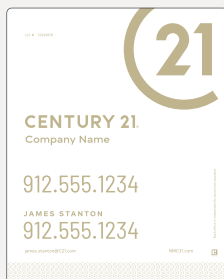

H - SEAL - WHITE

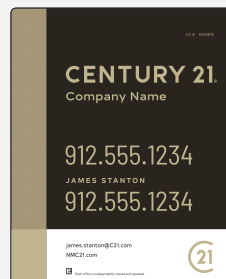

I - MOSAIC - BLACK

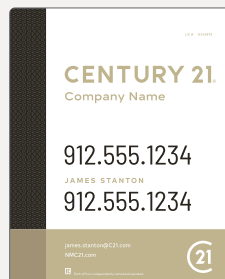

J - MOSAIC - WHITE



E - WORDMARK - BLACK



F - WORDMARK - WHITE

30X24 REPLACEMENT PANELS FOR FRAMES

24 Ga Steel Panels

ITEM	STYLE	3	5	10	15	25	50	100
21Z779	Agent Panel-C / D	26.95	22.50	20.05	19.30	18.45	17.90	17.60
21Z779-OP	Office Panel-C / D	26.95	22.50	20.05	19.30	18.45	17.90	17.60
21Z782	Agent Panel-A / B	26.95	22.50	20.05	19.30	18.45	17.90	17.60
21Z782-OP	Office Panel-A / B	26.95	22.50	20.05	19.30	18.45	17.90	17.60

Aluminum Panels

21A779	Agent Panel-C / D	37.35	28.75	25.50	24.80	23.95	23.50	23.25
21A779-OP	Office Panel-C / D	37.35	28.75	25.50	24.80	23.95	23.50	23.25
21A782	Agent Panel-A / B	37.35	28.75	25.50	24.80	23.95	23.50	23.25
21A782-OP	Office Panel-A / B	37.35	28.75	25.50	24.80	23.95	23.50	23.25

Aluminum Composite Panels

21L779	Agent Panel-C / D	33.00	28.20	23.25	21.90	21.10	20.70	19.85
21L779-OP	Office Panel-C / D	33.00	28.20	23.25	21.90	21.10	20.70	19.85
21L782	Agent Panel-A / B	33.00	28.20	23.25	21.90	21.10	20.70	19.85
21L782-OP	Office Panel-A / B	33.00	28.20	23.25	21.90	21.10	20.70	19.85

Steel Reflective Panels

21Z779R	Agent Panel-C / D	51.25	45.45	40.25	38.75	37.70	37.15	36.85
21Z779R-OP	Office Panel-C / D	51.25	45.45	40.25	38.75	37.70	37.15	36.85
21Z782R	Agent Panel-A / B	51.25	45.45	40.25	38.75	37.70	37.15	36.85
21Z782R-OP	Office Panel-A / B	51.25	45.45	40.25	38.75	37.70	37.15	36.85

Aluminum Composite Reflective Panels

21L779R	Agent Panel-C / D	52.55	47.25	43.50	43.20	40.90	40.30	40.10
21L779R-OP	Office Panel-C / D	52.55	47.25	43.50	43.20	40.90	40.30	40.10
21L782R	Agent Panel-A / B	52.55	47.25	43.50	43.20	40.90	40.30	40.10
21L782R-OP	Office Panel-A / B	52.55	47.25	43.50	43.20	40.90	40.30	40.10

Price each.

30X24 HANGING PANELS

24 Ga Steel Panels

ITEM	STYLE	3	5	10	15	25	50	100
21Z879	Agent Panel-C / D	30.80	25.70	22.75	21.65	20.70	20.10	19.70
21Z879-OP	Office Panel-C / D	30.80	25.70	22.75	21.65	20.70	20.10	19.70
21Z882	Agent Panel-E / F	30.80	25.70	22.75	21.65	20.70	20.10	19.70
21Z882-OP	Office Panel-E / F	30.80	25.70	22.75	21.65	20.70	20.10	19.70
21Z884	Agent Panel-A / B	30.80	25.70	22.75	21.65	20.70	20.10	19.70
21Z884-OP	Office Panel-A / B	30.80	25.70	22.75	21.65	20.70	20.10	19.70

Aluminum Panels

21A879	Agent Panel-C / D	35.85	33.10	27.85	27.35	26.80	26.40	26.05
21A879-OP	Office Panel-C / D	35.85	33.10	27.85	27.35	26.80	26.40	26.05
21A882	Agent Panel-E / F	35.85	33.10	27.85	27.35	26.80	26.40	26.05
21A882-OP	Office Panel-E / F	35.85	33.10	27.85	27.35	26.80	26.40	26.05
21A884	Agent Panel-A / B	35.85	33.10	27.85	27.35	26.80	26.40	26.05
21A884-OP	Office Panel-A / B	35.85	33.10	27.85	27.35	26.80	26.40	26.05

Aluminum Composite Panels

21L879	Agent Panel-C / D	34.40	29.45	24.20	23.25	22.10	21.00	20.85
21L879-OP	Office Panel-C / D	34.40	29.45	24.20	23.25	22.10	21.00	20.85
21L882	Agent Panel-E / F	34.40	29.45	24.20	23.25	22.10	21.00	20.85
21L882-OP	Office Panel-E / F	34.40	29.45	24.20	23.25	22.10	21.00	20.85
21L884	Agent Panel-A / B	34.40	29.45	24.20	23.25	22.10	21.00	20.85
21L884-OP	Office Panel-A / B	34.40	29.45	24.20	23.25	22.10	21.00	20.85

Aluminum Composite Reflective Panels

21L879R	Agent Panel-C / D	55.45	49.95	43.85	43.15	41.65	41.10	40.45
21L879R-OP	Office Panel-C / D	55.45	49.95	43.85	43.15	41.65	41.10	40.45
21L882R	Agent Panel-E / F	55.45	49.95	43.85	43.15	41.65	41.10	40.45
21L882R-OP	Office Panel-E / F	55.45	49.95	43.85	43.15	41.65	41.10	40.45
21L884R	Agent Panel-A / B	55.45	49.95	43.85	43.15	41.65	41.10	40.45
21L884R-OP	Office Panel-A / B	55.45	49.95	43.85	43.15	41.65	41.10	40.45

Price each.

30X24 AGENT PANELS

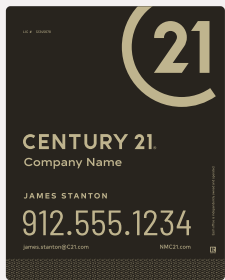

A - SEAL - BLACK

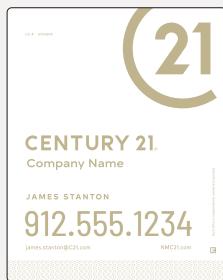

B - SEAL - WHITE

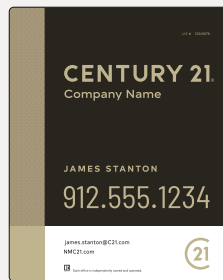

C - MOSAIC - BLACK

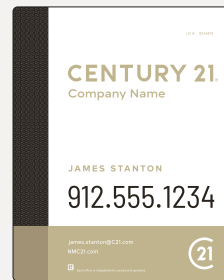

D - MOSAIC - WHITE



E - WORDMARK - BLACK

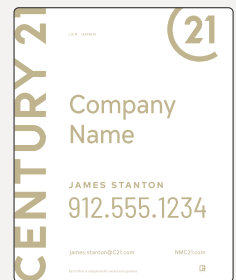

F - WORDMARK - WHITE

30X24 OFFICE PANELS



A - SEAL - BLACK



B - SEAL - WHITE

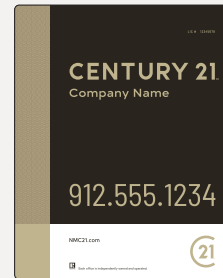

C - MOSAIC - BLACK

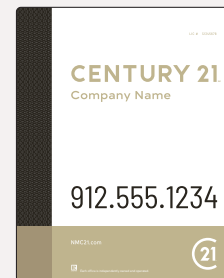

D - MOSAIC - WHITE

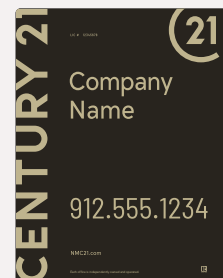

E - WORDMARK - BLACK



F - WORDMARK - WHITE

DIRECTIONAL SIGNS



21P954CD-300



21Z954AB-300



21Z957AB-300

18 X 24 POLY A-FRAME UNITS

Polyethylene Panel Units

ITEM	STYLE	3	5	10	15	25	50	100
21P954AB-300	Open House Unit	A / B	58.35	47.25	40.60	39.55	38.55	37.45
21P954AB-306	For Sale Unit	A / B	58.35	47.25	40.60	39.55	38.55	37.45
21P954CD-300	Open House Unit	C / D	58.35	47.25	40.60	39.55	38.55	37.45
21P954CD-306	For Sale Unit	C / D	58.35	47.25	40.60	39.55	38.55	37.45
21P954E-300	Open House Unit	E	58.35	47.25	40.60	39.55	38.55	37.45
21P954E-306	For Sale Unit	E	58.35	47.25	40.60	39.55	38.55	37.45
21P954FG-300	Open House Unit	F / G	58.35	47.25	40.60	39.55	38.55	37.45
21P954FG-306	For Sale Unit	F / G	58.35	47.25	40.60	39.55	38.55	37.45

Price each.

18 X 24 STEEL A-FRAME UNITS

24 Ga Steel Panel Units

ITEM	STYLE	3	5	10	15	25	50	100
21Z954AB-300	Open House Unit	A / B	63.00	54.90	49.15	46.70	45.00	43.50
21Z954AB-306	For Sale Unit	A / B	63.00	54.90	49.15	46.70	45.00	43.50
21Z954CD-300	Open House Unit	C / D	63.00	54.90	49.15	46.70	45.00	43.50
21Z954CD-306	For Sale Unit	C / D	63.00	54.90	49.15	46.70	45.00	43.50
21Z954E-300	Open House Unit	E	63.00	54.90	49.15	46.70	45.00	43.50
21Z954E-306	For Sale Unit	E	63.00	54.90	49.15	46.70	45.00	43.50
21Z954FG-300	Open House Unit	F / G	63.00	54.90	49.15	46.70	45.00	43.50
21Z954FG-306	For Sale Unit	F / G	63.00	54.90	49.15	46.70	45.00	43.50

Price each.

18 X 24 ROUND ROD UNITS

24 Ga Steel Panel Units - Black Frame

ITEM	STYLE	3	5	10	15	25	50	100
21Z957AB-300	Open House Unit	A / B	43.00	34.05	31.60	30.80	30.00	29.85
21Z957AB-306	For Sale Unit	A / B	43.00	34.05	31.60	30.80	30.00	29.85
21Z957CD-300	Open House Unit	C / D	43.00	34.05	31.60	30.80	30.00	29.85
21Z957CD-306	For Sale Unit	C / D	43.00	34.05	31.60	30.80	30.00	29.85
21Z957E-300	Open House Unit	E	43.00	34.05	31.60	30.80	30.00	29.85
21Z957E-306	For Sale Unit	E	43.00	34.05	31.60	30.80	30.00	29.85
21Z957FG-300	Open House Unit	F / G	43.00	34.05	31.60	30.80	30.00	29.85
21Z957FG-306	For Sale Unit	F / G	43.00	34.05	31.60	30.80	30.00	29.85

24 Ga Steel Panel Units - White Frame

21Z957ABW-300	Open House Unit	A / B	43.00	34.05	31.60	30.80	30.00	29.85
21Z957ABW-306	For Sale Unit	A / B	43.00	34.05	31.60	30.80	30.00	29.85
21Z957CDW-300	Open House Unit	C / D	43.00	34.05	31.60	30.80	30.00	29.85
21Z957CDW-306	For Sale Unit	C / D	43.00	34.05	31.60	30.80	30.00	29.85
21Z957EW-300	Open House Unit	E	43.00	34.05	31.60	30.80	30.00	29.85
21Z957EW-306	For Sale Unit	E	43.00	34.05	31.60	30.80	30.00	29.85
21Z957FGW-300	Open House Unit	F / G	43.00	34.05	31.60	30.80	30.00	29.85
21Z957FGW-306	For Sale Unit	F / G	43.00	34.05	31.60	30.80	30.00	29.85

Price each.

18 X 24 CORRUGATED PLASTIC PANELS

ITEM	STYLE	3	5	10	15	25	50	100
21C850AB-300	Open House	A / B	18.80	14.75	11.20	9.60	8.55	7.55
21C850AB-306	For Sale	A / B	18.80	14.75	11.20	9.60	8.55	7.55
21C850CD-300	Open House	C / D	18.80	14.75	11.20	9.60	8.55	7.55
21C850CD-306	For Sale	C / D	18.80	14.75	11.20	9.60	8.55	7.55
21C850E-300	Open House	E	18.80	14.75	11.20	9.60	8.55	7.55
21C850E-306	For Sale	E	18.80	14.75	11.20	9.60	8.55	7.55
21C850FG-300	Open House	F / G	18.80	14.75	11.20	9.60	8.55	7.55
21C850FG-306	For Sale	F / G	18.80	14.75	11.20	9.60	8.55	7.55

H-Frame Wire Stake

21-687	5.10	3.65
--------	------	------

Price each.

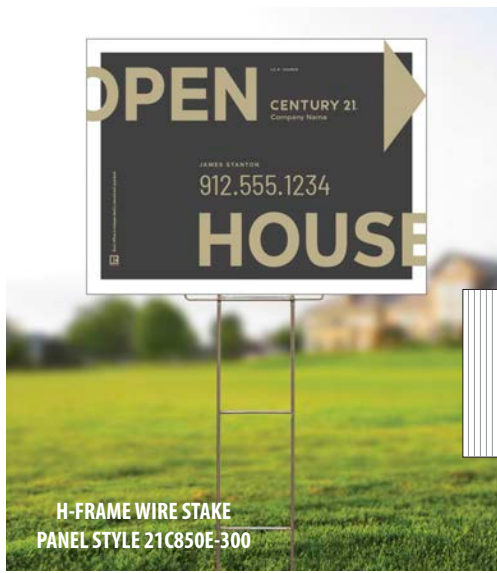

Use these lightweight, moisture proof, 4mm corrugated plastic signs where cost is a factor. They will fit our H-Frame Wire Stake (sold separately). Signs are available with vertical flutes only and are printed on both sides. Personalized at no extra charge.

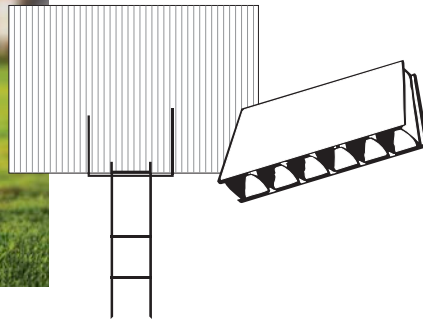

FEATHER FLAG

These full-color flags stay open without a breeze so your message is always visible. On windy days, they flutter and swing freely on a rotating base. The pole is easy to assemble and install.

ITEM	1	3	5	10
Feather Flag	75.60	63.10	60.20	59.45

Price each.



PANEL STYLES



NEXT DAY RIDERS

21Z179 **SOLD** SHOWN BY APPOINTMENT STYLE A

FOR SALE	FOR LEASE	PENDING
OPEN	WATERFRONT	POOL
OPEN HOUSE →	ACREAGE	JUST LISTED
NEW PRICE	COMING SOON!	OPEN SUNDAY

21Z179W **SOLD** SHOWN BY APPOINTMENT STYLE B

FOR SALE	FOR LEASE	PENDING
OPEN	WATERFRONT	POOL
OPEN HOUSE →	ACREAGE	JUST LISTED
NEW PRICE	COMING SOON!	OPEN SUNDAY

21Z185 **SOLD** STYLE C 21Z185W **SOLD** STYLE D

From **Just Listed** to **Sold**, there is plenty of information you may want to communicate to buyers over the life of a listing. With our **Next Day Rider Program** you can change your message quickly and conveniently. Your riders are produced in less than 24 hours from order approval and then shipped to you.

6 X 24 MESSAGE RIDERS

ITEM		10
21Z179	Style A	6.65
21Z179W	Style B	6.65
21Z185	Style C	6.65
21Z185W	Style D	6.65

Price each.

JAMES STANTON 912.555.1234 STYLE A	JAMES STANTON 912.555.1234 STYLE B	JAMES STANTON 912.555.1234 STYLE C	JAMES STANTON 912.555.1234 STYLE D	JAMES STANTON 912.555.1234 STYLE E
--	--	--	--	--





6 X 24 AGENT RIDERS

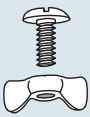

ITEM	STYLE	3	5	10	15	25	50	100
21Z180	All	10.85	8.85	6.65	6.35	5.75	5.20	5.05

Price each.

JAMES STANTON 912.555.1234 STYLE A	JAMES STANTON 912.555.1234 STYLE B
T JAMES STANTON 912.555.1234 STYLE A	T JAMES STANTON 912.555.1234 STYLE B

HARDWARE

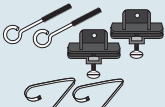
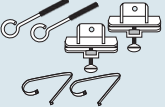
ITEM	Price
 12-700-100 RIDER SETS BAG OF 100	12.75
 12-700-24 RIDER SETS BAG OF 24	4.15
 12-702-100 SIGN PANEL SETS BAG OF 100	8.55
 12-702-25 SIGN PANEL SETS BAG OF 25	3.60
 12-708-20 SAFETY PIN CLIPS BAG OF 20	8.15

ITEM	Price
 12-729B ALUMINUM POST HARDWARE KIT - BLACK	5.25
 12-729W ALUMINUM POST HARDWARE KIT - WHITE	5.25
 12-733 PLASTIC EXTENSION PINS PAIR	2.40

SIGN FRAMES AND POSTS

18 X 24

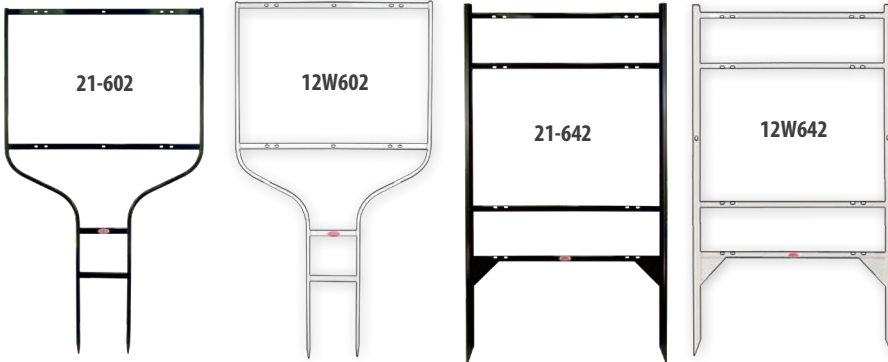

ITEM		1	3	5+
21-602	18 x 24 Round Rod - Black	27.40	17.85	16.20
12W602	18 x 24 Round Rod - White	27.40	17.85	16.20
21-642	18 x 24 Angle Iron 2 Insert Black	29.60	20.10	18.30
12W642	18 x 24 Angle Iron 2 Insert White	29.60	20.10	18.30
21-627	22 x 24 Angle Iron Black	28.10	18.70	16.85
12W627	22 x 24 Angle Iron White	28.10	18.70	16.85
21-645	22 x 24 Angle Iron 2 Insert Black	31.30	21.70	20.05
12W647	22 x 24 Angle Iron 2 Insert White	31.30	21.70	20.05
12-628	24 x 24 Angle Iron Black	31.45	20.65	19.60
12W628	24 x 24 Angle Iron White	31.45	20.65	19.60
12-648	24 x 24 Angle Iron 2 Insert Black	33.75	22.85	21.10
12W648	24 x 24 Angle Iron 2 Insert White	33.75	22.85	21.10
12-631	30 x 24 Angle Iron Black	31.30	21.20	19.25
12W631	30 x 24 Angle Iron White	31.30	21.20	19.25
21-502	Aluminum Post Black	74.00	55.70	51.75
21W505	Aluminum Post White	74.00	55.70	51.75
21G505	Aluminum Post Gold	91.05	65.05	58.05

22 X 24

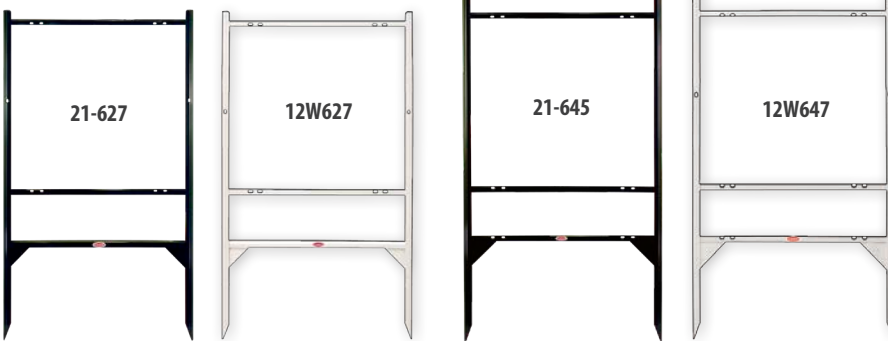

24 X 24

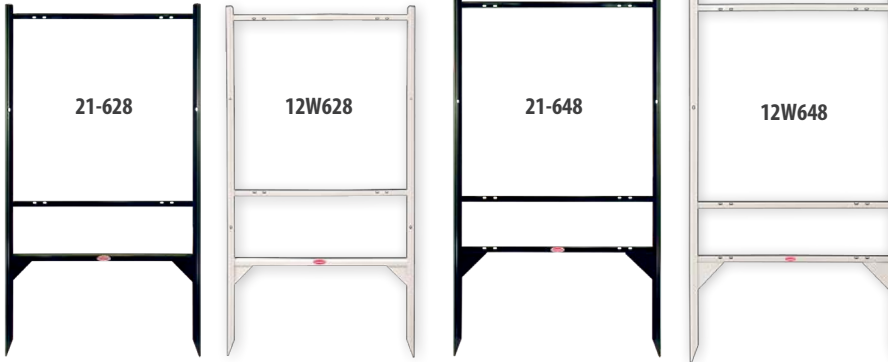

30 X 24

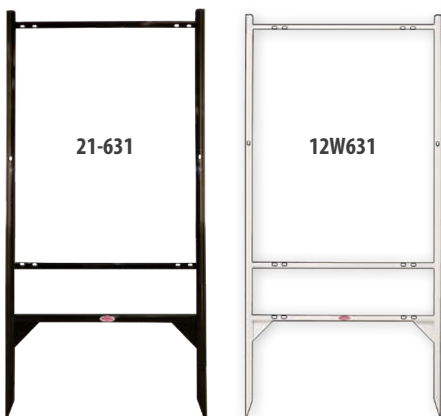

ALUMINUM POSTS

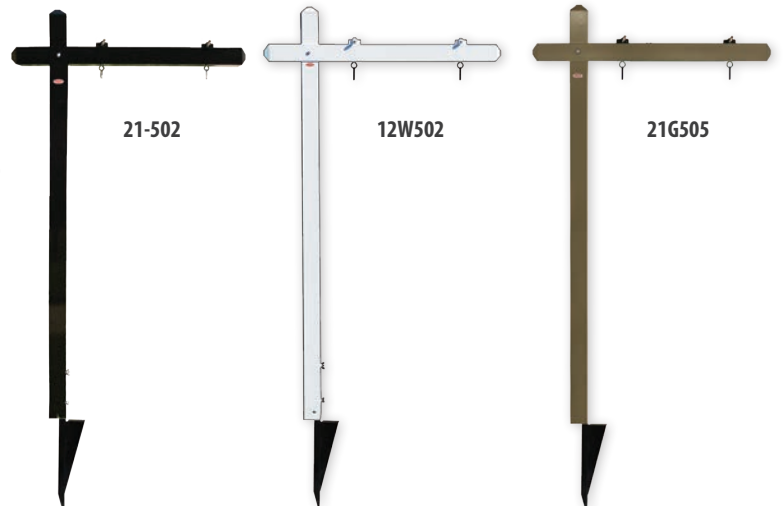

Price each.

"Very impressed! Wow!
Wow! Not even a week and
I got a really NICE product.
Thank you!" - Haniya N.

We pride ourselves on personal and professional customer service. A real person answers the phone each time you call. No automated voice systems! An experienced Customer Service Representative keeps track of your order from start-to-finish to insure everything goes right.

No matter where you call home,
We'll help you sell homes.

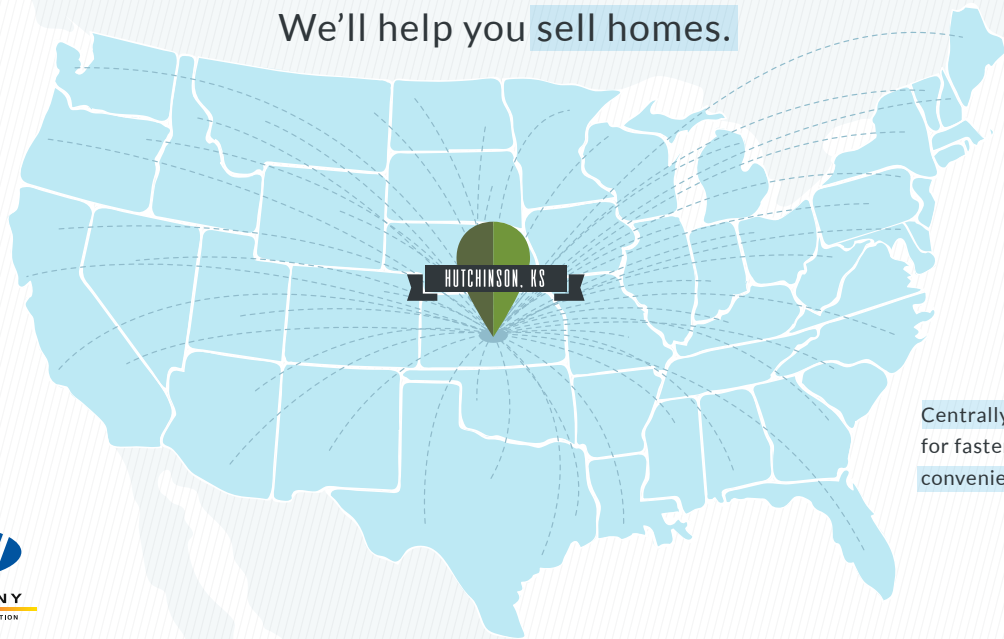

Centrally located
for faster, more
convenient shipping.



Professional Signage for Real Estate Professionals

CENTURY 21
Business Benefits

All specifications in this catalog supersede previous catalogs and are subject to change without notice. Please go to www.lowensign.com for current prices and information. We reserve the right to correct typographical errors. The design and contents of this catalog are copyrighted.

You can find us on social media.
Follow and Like us today!

CALL 800-545-5505 FAX 800-846-4466 LOWENSIGN.COM

