

INDEPENDENT CATALOG



OUR 3 DAY PRODUCTION TIME IS THE FASTEST IN THE INDUSTRY!

800.545.5505  
LOWENSIGN.COM

**LOWEN**  
SIGN COMPANY  
A DIVISION OF LOWEN CORPORATION



## WHAT YOU GET WHEN YOU WORK WITH LOWEN SIGN COMPANY

We know you're busy. That's why Lowen Sign Company is continuously improving the products and services we provide. Order tracking and management tools at [lowensign.com](http://lowensign.com) make it easy to reorder your yard signs and see what orders are on the way. You can even order signage on-the-go with your mobile device!

This hassle free experience is made even better with the fastest production time in the industry. Once you approve your order, signs are produced in just 3 days. They're then shipped promptly with tracking info provided in your [lowensign.com](http://lowensign.com) account.

**"I HAD CALLED ANOTHER COMPANY FOR A QUOTE BEFORE ORDERING FROM LOWEN. THEY WERE HIGHER IN PRICE AND WANTED TO CHARGE ME MORE BECAUSE I WAS CONCERNED ABOUT THE DELIVERY TIME. I WENT ONLINE AT LOWEN AND BEFORE I PUSHED SEND, I CALLED IN AND GOT A CUSTOMER SERVICE REPRESENTATIVE. SHE WALKED ME THROUGH THINGS AND HELPED TO EXPEDITE MY ORDER WHICH WENT OUT IN RECORD TIME."**

**- SUSAN FIKE**



## SUPERIOR MATERIALS

Advanced printing technology ensures a beautiful sign with a message that will last. All steel panels and frames are manufactured by us and are sealed with a powder coat for durability and longevity. We pride ourselves on overseeing the details of our products from start to finish.



## FAST PRODUCTION TIME

**Our 3 day production time is the fastest in the industry!**

We've advanced our art systems, invested in the newest printing technology, and expanded our work force to achieve a 3 Day Production Program. This program ensures sign delivery in record time. Your order is produced and ready to ship just 3 days after order approval.



## CUSTOMER SERVICE

When you call Lowen, a real person answers the phone every time. There's no automated voice system here. Our friendly and knowledgeable representatives make sure you get the perfect signage for your professional real estate needs.



## WEBSITE FEATURES

We've worked hard to make our website mobile friendly. That means it's easy to order signs on-the-go from your phone or tablet. The biggest advantage to our website are the account features such as Order History and Shipment Tracking.



## CENTRALLY LOCATED

All of our signage and frames are made in the U.S.A.! We manufacture our products from raw materials at our headquarters in Hutchinson, Kansas. Because of our central location in the heart of America, we have the advantage of fast delivery to anywhere in the country.

# LOWESIGN.COM

Leave the cluttered, confusing, online ordering experience behind.



1

ACCESS FROM YOUR TABLET OR MOBILE FOR ON-THE-GO ORDERING.

2

ORDER HISTORY FOR ONE CLICK REORDERING OF YOUR FAVORITE PRODUCTS.

3

KNOW WHEN TO EXPECT YOUR ORDER WITH SHIPMENT TRACKING.

4

EASILY CUSTOMIZE YOUR REAL ESTATE SIGNAGE.

# WHAT SIGN MATERIAL IS RIGHT FOR ME? ▶



## Advertise your listing day and night!

Add a reflective finish to your sign panels for visibility 24/7. Reflective vinyl reflects the light from headlights so that drivers can see your message in the dark. Our industrial vinyl has the highest reflectivity in the industry.

## RESIDENTIAL SIGN MATERIALS

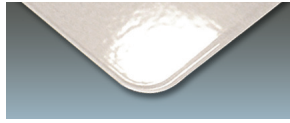

### POWDER COATED STEEL

A strong material for the highest quality sign. Powder coated to prevent rust and for a porcelain finish. Includes protective clear coat.



### POLYETHYLENE (POLY)

Durable and lightweight material that will not corrode. Bowing may occur in extreme temperatures or after long use. Includes protective clear coat.

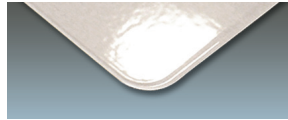

### POWDER COATED ALUMINUM

This is a great material for coastal or rainy areas because aluminum will not rust. Panels pair well with aluminum sign posts. Includes protective clear coat.

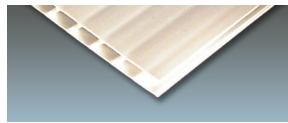

### CORRUGATED PLASTIC

These rigid panels can be printed single or double-sided and cut-to-shape. Our most economical option is great for directional signs.

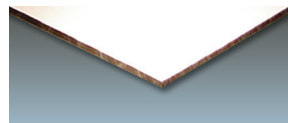

### ALUMINUM COMPOSITE

Very strong but lightweight substrate produced by bonding two aluminum sheets to a polyethylene core. Includes protective clear coat.

## COMMERCIAL SIGN MATERIALS



### POWDER COATED STEEL

A strong material for the highest quality sign. Powder coated to prevent rust and for a porcelain finish. Includes protective clear coat.

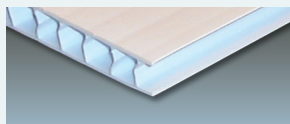

### CORRUGATED PLASTIC

These rigid panels can be printed single or double-sided and cut-to-shape. The thicker, 10 mm panels are a durable option that easily fit over our H-Stakes.

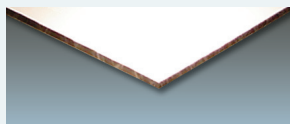

### ALUMINUM COMPOSITE

Very strong but lightweight substrate produced by bonding two aluminum sheets to a polyethylene core. Includes protective clear coat.

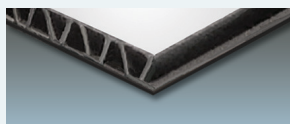

### ALUPALITE

Two aluminum sheets are bonded to either side of a high-density, corrugated plastic core to form this strong substrate. Includes protective clear coat.

# LOWEN PROVIDES MORE

We won't nickel and dime you! While other suppliers have never ending discounts and flash sales, Lowen will always have your products priced as low as possible year round. We don't like fine print and try to work with each individual customer to provide them with the signage they need for the best price.



## WE PROVIDE LASTING QUALITY AT THE BEST PRICE.

These features come standard when you order from Lowen.

- **CLEAR COAT** blocks UV rays to protect your image.
- **POWDER COAT** prevents rust and provides a luxurious finish.
- **BRASS GROMMETS** prevent holes from ripping out and protects the sign finish.
- **ROUNDED CORNERS** and edges present a finished look while protecting your safety.
- **FULLY ASSEMBLED** signs allow you to go from box to yard with no extra work.

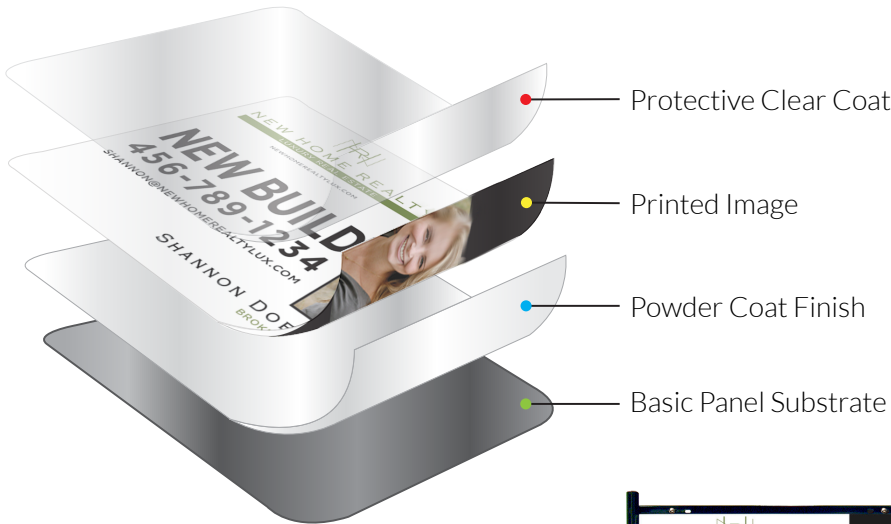

**CUSTOM ART AND DESIGN** Our experienced Sign Artists are available to make your signage truly unique. They can work with an existing design to make it fit any size or shape of sign you choose. They can also create a 100% new design just for you.

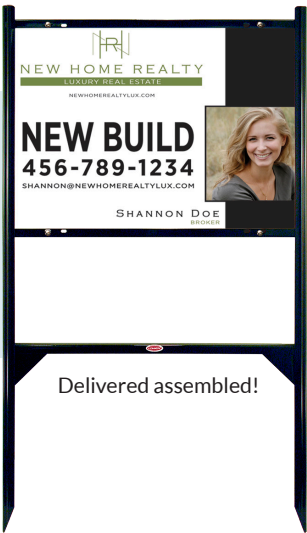

# SIGN UNITS



ALUMINUM POST UNITS

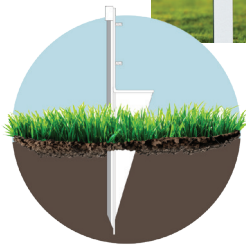

## GROUND ANCHOR

Item # 12-713

Post slips over ground anchor and fastens with two wing nuts. Hardware is included. \$15.30 each.



ROUND ROD UNITS

## ALUMINUM POST UNITS

### Aluminum Sign Post and Steel Panel Units

ITEM		5	10	15	25	50	100
12Z975	18 x 24 - 24 Ga. Steel White	89.70	82.00	74.90	68.05	64.30	59.75
12Z975B	18 x 24 - 24 Ga. Steel Black	89.10	81.40	74.30	67.45	63.70	59.10
12Z976	18 x 24 - 20 Ga. Steel White	94.95	87.00	79.55	72.40	68.55	63.70
12Z976B	18 x 24 - 20 Ga. Steel Black	94.25	86.30	78.85	71.70	67.85	63.00
12Z977	18 x 30 - 24 Ga. Steel White	93.10	85.15	77.95	70.95	67.20	62.40
12Z975R	18 x 24 - 24 Ga. Steel Reflective White	103.90	95.50	87.50	79.65	75.40	70.10
12Z975RB	18 x 24 - 24 Ga. Steel Reflective Black	103.25	94.75	86.85	79.00	74.75	69.45

### Aluminum Sign Post and Aluminum Panel Units

12A971	30 x 24 - .063 Aluminum White	105.40	100.50	93.00	91.65	86.60	82.95
12A971B	30 x 24 - .063 Aluminum Black	104.75	99.85	92.35	91.00	85.95	82.30
12A975	18 x 24 - .063 Aluminum White	91.00	85.75	80.10	78.90	75.25	72.70
12A975B	18 x 24 - .063 Aluminum Black	90.00	85.10	79.45	78.25	74.60	72.05
12A978	24 x 24 - .063 Aluminum White	97.45	93.85	87.05	85.65	81.25	78.00
12A978B	24 x 24 - .063 Aluminum Black	96.80	83.20	86.40	85.00	80.60	77.35

Price each. Unit includes panel, post, hardware and ground anchor. Riders sold separately. Shipped unassembled, FOB Lowen.

## ROUND ROD UNITS

### Round Rod and Steel Panel Units

ITEM		5	10	15	25	50	100
12Z901	24 x 18 - 24 Ga. Steel Black	47.00	44.80	41.15	37.20	35.10	32.35
12Z902	18 x 24 - 24 Ga. Steel Black	45.60	43.10	39.45	35.30	30.65	28.25
12Z902W	18 x 24 - 24 Ga. Steel White	46.25	43.75	40.00	35.80	31.05	28.70
12Z903	18 x 30 - 24 Ga. Steel Black	63.35	59.55	53.45	48.20	41.85	38.80
12Z905	28 x 20 - 24 Ga. Steel Black	54.80	51.40	45.35	40.75	35.45	32.75
12Z906	20 x 28 - 24 Ga. Steel Black	58.95	55.20	48.80	44.00	38.20	35.45
12Z906W	20 x 28 - 24 Ga. Steel White	59.35	55.50	49.05	44.20	38.35	35.55
12Z908	24 x 24 - 24 Ga. Steel Black	54.80	51.15	45.75	41.60	36.55	34.00
12Z908W	24 x 24 - 24 Ga. Steel White	54.00	50.40	44.95	40.80	35.80	33.30
12Z902R	18 x 24 - 24 Ga. Steel Reflective Black	64.30	60.00	54.70	49.15	46.10	42.40
12Z902RW	18 x 24 - 24 Ga. Steel Reflective White	70.75	63.25	58.20	51.30	48.15	44.35
12Z906R	20 x 28 - 24 Ga. Steel Reflective Black	82.60	77.00	68.40	61.80	58.10	53.50
12Z906RW	20 x 28 - 24 Ga. Steel Reflective White	82.95	77.30	68.60	62.00	58.30	53.70
12Z908R	24 x 24 - 24 Ga. Steel Reflective Black	83.00	76.80	68.50	61.95	58.30	53.70

### Round Rod and Aluminum Panel Units

12A902	18 x 24 - .040 Aluminum Black	50.30	44.45	40.25	37.25	32.35	31.55
12A902W	18 x 24 - .040 Aluminum White	50.20	44.35	40.15	37.15	32.25	31.45
12A903	18 x 30 - .040 Aluminum Black	69.05	62.55	56.40	51.60	45.15	42.05
12A908	24 x 24 - .040 Aluminum Black	63.65	52.15	47.80	44.00	38.50	35.90
12A908W	24 x 24 - .040 Aluminum White	63.35	51.85	47.50	43.70	38.20	35.60

Price each. Shipped assembled FOB Lowen.

## ANGLE IRON 2-INSERT UNITS

### Angle Iron Sign Frame and Panel Units for 2 Riders with Steel Panels

ITEM		5	10	15	25	50	100
12Z941	24 x 18 - 24 Ga. Steel 2 Insert Black	56.85	50.25	44.85	39.55	36.55	33.30
12Z941W	24 x 18 - 24 Ga. Steel 2 Insert White	56.65	49.95	44.55	39.25	36.15	33.00
12Z942	18 x 24 - 24 Ga. Steel 2 Insert Black	55.90	49.35	44.00	38.80	35.95	32.80
12Z942W	18 x 24 - 24 Ga. Steel 2 Insert White	55.35	48.60	43.35	38.20	35.30	32.20
12Z946	20 x 28 - 24 Ga. Steel 2 Insert Black	66.20	58.10	50.55	44.85	41.55	37.95
12Z946W	20 x 28 - 24 Ga. Steel 2 Insert White	65.45	57.30	49.80	44.10	40.80	37.20
12Z948	24 x 24 - 24 Ga. Steel 2 Insert Black	66.65	58.05	50.55	44.95	41.55	37.90
12Z948W	24 x 24 - 24 Ga. Steel 2 Insert White	66.60	58.00	50.50	44.90	41.50	37.85
12Z942R	18 x 24 - 24 Ga. Steel 2 In Reflective Black	83.45	73.55	65.25	57.45	58.90	44.95
12Z946R	20 x 28 - 24 Ga. Steel 2 In Reflective Black	100.60	88.80	77.20	68.35	58.40	53.55
12Z948R	24 x 24 - 24 Ga. Steel 2 In Reflective Black	99.80	87.50	76.15	67.45	57.55	52.70

### Angle Iron Sign Frame and Panel Units for 2 Riders with Aluminum Panels

12A942	18 x 24 - .040 Aluminum 2-Insert Black	57.35	48.90	44.50	40.80	37.15	34.05
12A942W	18 x 24 - .040 Aluminum 2-Insert White	56.95	48.50	44.10	40.30	36.75	33.65
12A943	18 x 24 - .040 Aluminum 1-Insert Black	54.85	48.25	42.95	38.15	34.85	32.85
12A948	24 x 24 - .040 Aluminum 2-Insert Black	69.70	57.85	52.60	47.30	43.50	39.85
12Z948W	24 x 24 - .040 Aluminum 2-Insert White	69.70	57.85	52.60	47.30	43.50	39.85

Price each. Riders sold separately. Shipped assembled FOB Lowen.

## ANGLE IRON UNITS

### Angle Iron Sign Frame with Steel Panels

ITEM		5	10	15	25	50	100
12Z921	24 x 18 - 24 Ga. Steel Black	52.80	46.05	40.90	35.90	30.55	27.95
12Z922	18 x 24 - 24 Ga. Steel Black	53.25	46.90	41.70	36.65	31.35	28.80
12Z922W	18 x 24 - 24 Ga. Steel White	52.80	46.35	41.20	36.20	30.90	28.35
12Z924	18 x 30 - 24 Ga. Steel Black	67.40	58.55	50.70	44.40	37.25	34.10
12Z926	20 x 28 - 24 Ga. Steel Black	63.00	55.30	47.75	42.20	36.25	33.50
12Z928	24 x 24 - 24 Ga. Steel Black	63.15	55.00	47.70	42.30	36.25	33.25
12Z928W	24 x 24 - 24 Ga. Steel White	62.90	54.70	47.40	42.05	36.00	32.95
12Z930	24 x 30 - 24 Ga. Steel Black	69.75	61.90	53.80	47.80	41.05	38.00
12Z932	30 x 42 - 24 Ga. Steel Black	150.00	132.45	116.70	104.40	97.60	89.30
12Z960	30 x 24 - 24 Ga. Steel Black	73.85	65.05	55.75	48.95	44.95	40.80
12Z924R	18 x 30 - 24 Ga. Steel Reflective Black	82.55	73.00	64.60	57.45	53.25	48.85
12Z928R	24 x 24 - 24 Ga. Steel Reflective Black	85.55	75.55	66.30	59.30	55.20	50.50

### Angle Iron Sign Frame with Aluminum Panels

12A922	18 x 24 - .040 Aluminum Black	57.95	48.25	42.50	38.65	33.10	30.00
12A922W	18 x 24 - .040 Aluminum White	57.80	48.10	42.35	38.50	32.95	29.85
12A924	18 x 30 - .040 Aluminum Black	73.75	62.20	54.30	48.40	41.20	38.00
12A924W	18 x 30 - .040 Aluminum White	73.25	61.70	53.80	47.90	40.70	37.50
12A928	24 x 24 - .040 Aluminum Black	72.00	56.00	49.80	44.70	38.20	35.20
12A928W	24 x 24 - .040 Aluminum White	71.80	55.80	49.60	44.50	38.00	35.00

Price each. Shipped assembled FOB Lowen.



ANGLE IRON  
2-INSERT UNITS

The Angle Iron 2-insert and Arc units feature spring clips for quick and easy rider installation.



ANGLE IRON UNITS

# SIGN UNITS



ARC UNIT



TUBULAR STAKE UNIT



H-STAKE UNIT

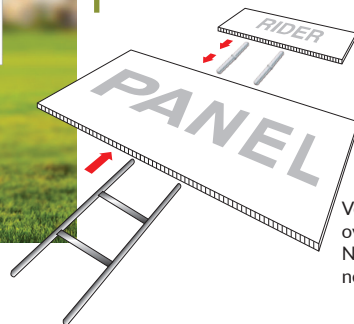

Vertical flutes fit over wire stake. No hardware needed!

## ARC UNITS

### Arc Sign Frame and Panel Unit

ITEM		5	10	15	25	50	100
12Z945W	30 x 24 - 24 Ga. Steel 2 Insert White	80.95	73.20	70.90	64.15	60.15	59.60
12Z949	27 x 24 - 24 Ga. Steel Black	72.90	66.40	64.30	58.60	55.25	54.55
12Z949W	27 x 24 - 24 Ga. Steel White	72.15	65.55	63.55	57.90	54.55	53.95
12Z945RW	30 x 24 - 24 Ga. Steel 2 In Reflective White	124.70	112.05	99.05	89.30	83.60	77.00
12Z949R	27 x 24 - 24 Ga. Steel Reflective Black	120.50	108.45	96.10	86.60	81.20	74.65
12Z949RW	27 x 24 - 24 Ga. Steel Reflective White	119.35	107.35	95.05	8.65	80.30	73.90

Price each. Riders sold separately. Shipped assembled FOB Lowen.

## TUBULAR STAKE UNITS

### Tubular Stake Sign and Panel Unit

ITEM		5	10	15	25	50	100
12Z995	18 x 24 - 24 Ga. Steel Black	58.15	51.65	47.35	42.10	39.35	36.40
12Z995W	18 x 24 - 24 Ga. Steel White	57.40	50.80	46.55	41.35	38.55	35.60
12P995	18 x 24 - .150 Poly Black	54.45	58.65	43.95	40.20	36.95	36.40
12P995W	18 x 24 - .150 Poly White	55.05	49.00	44.25	40.40	37.10	34.35

Price each. Riders sold separately. Shipped unassembled FOB Lowen.

## H-STAKE UNITS

### H-Stake and Sign Panel Unit with 10MM Corrugated Plastic Panels

ITEM		5	10	15	25	50	100
12C900	18 x 24 Round Rod Unit	30.95	26.80	24.35	20.85	19.05	17.30
12C854	18 x 24 Plastic Panel	23.40	19.85	17.55	13.75	11.50	11.15
12-697	Round Rod Stake	8.85					
12C275	*6 x 18 Message Riders	5.55 (Minimum order 10.)					
12C285	*6 x 24 Message Riders	5.70 (Minimum order 10.)					
12C270	6 x 18 Agent Riders	8.55	7.85	7.05	6.85	6.50	5.70
12C280	6 x 24 Agent Riders	8.85	8.35	7.35	7.20	6.80	5.95
12-733	Plastic Extension Pins	2.30 per pair					

Price each. Unit is panel and stake only. Riders and Plastic Extension Pins sold separately. Panels have vertical corrugations. Shipped unassembled FOB Lowen. \*Visit [www.lowensign.com](http://www.lowensign.com) for a complete list of stock message riders.

Sign units with polyethylene plastic panels and new aluminum panels shown at [lowensign.com](http://lowensign.com)



## ROUND ROD STAKE UNITS

### Round Rod Stake and Envelope Sign Panel Unit

ITEM		5	10	15	25	50	100
12C972	18 x 24 Jack Unit	35.30	30.20	26.80	23.00	20.65	18.85
12C410	18 x 24 Jack Panel	25.50	22.55	20.25	17.10	15.40	14.00
12-615	Round Rod Frame	9.80	8.35	7.95	7.35	7.20	7.00
12C175	*6 x 18 Message Riders	4.70 (Minimum order 10.)					
12C185	*6 x 24 Message Riders	5.05 (Minimum order 10.)					
12C170	6 X 18 Custom Riders	7.60	6.75	6.20	6.00	5.65	4.90
12C180	6 x 24 Custom Riders	7.95	7.30	6.45	6.35	5.95	5.15
12-513	H-Extender	2.20					

Price each. 4 mm riders and H-extenders sold separately. Panels are bonded on top and sides. Round Rod Frame slides between panels. Shipped unassembled FOB Lowen. \*Visit [www.lowensign.com](http://www.lowensign.com) for a complete list of message riders.

## FOOTBAR BASE STAKE UNITS

### Footbar Base Stake and Panel Unit

ITEM		5	10	15	25	50	100
12P935	24 x 24 - .050 Poly Footbar Unit	43.60	38.50	37.40	34.55	33.65	32.75
12P839	24 x 24 - .050 Poly Foldover Panel	30.15	26.80	23.25	18.95	17.25	16.80
12-689	Footbar Base Stake Only	14.20					
12P181	6x24 Poly Flipped Message Rider	9.25 (Minimum order 5.)					
12P183	6 x 24 .090 Poly Photo Tab Rider	13.35	12.70	10.05	9.30		
12P184	8 x 24 .150 Poly Photo Tab Rider	20.35	18.85	16.90	14.55		
12P188	6 x 24 .090 Poly Agent Tab Rider	10.55	9.90	8.85	8.65		
12P189	8 x 24 .150 Poly Agent Tab Rider	16.10	15.80	14.55	13.90		

Price each. Riders sold separately. Units shipped assembled FOB Lowen.



## ALUMINUM POST UNITS

### Aluminum Sign Post and Commercial Panel Units

ITEM		1	2	5
12Z980	36 x 36 - 24 Ga. Steel Unit	262.50	241.85	203.25
12Z882	36 x 36 - 24 Ga. D/F Panel	100.20	89.55	77.50
12-503	Post Only	126.80	112.05	103.55

Price each. Prices are for press-ready art. Unit includes posts, hardware, panel with scratch resistant clear-coat finish, and ground anchors. Rider sold separately. Shipped unassembled FOB, Lowen.

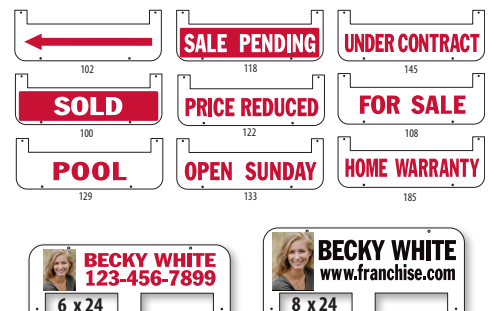
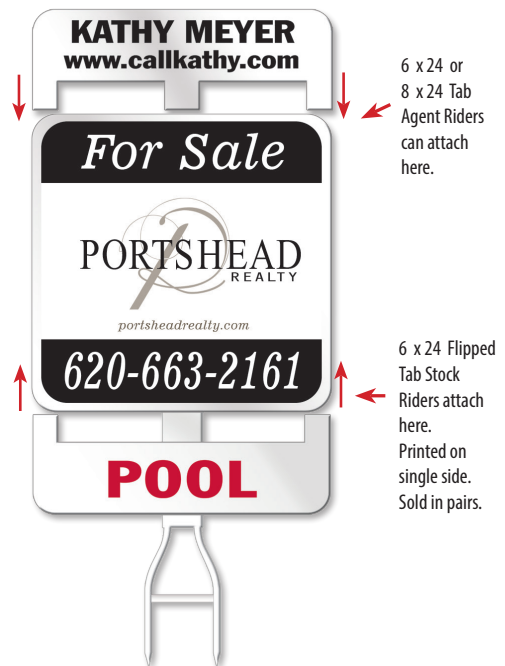

# NEXT DAY RIDERS

**MESSAGE RIDERS** From **Just Listed** to **Sold**, there is plenty of information you may want to communicate to buyers over the life of a listing. Your riders are produced in less than 24 hours from order approval and then shipped to you.

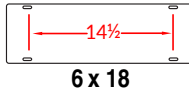

6 x 18

Rider Hole Patterns

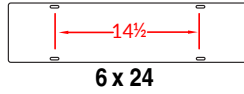

6 x 24

ITEM		10 or More
12Z175	6 x 18 Riders	5.15
12Z185	6 x 24 Riders	5.80
12Z195	6 x 28 Riders	5.95

Price each. Shipped FOB Lowen.

<b>ACCEPTED OFFER</b> 162	<b>___ BEDROOMS</b> 131	<b>FARM</b> 112	<b>JUST LISTED</b> 176	<b>UNDER CONTRACT</b> 145	<b>Waterfront</b> 126	<b>OPEN SUNDAY 1 to 3</b> 181	<b>WILL TRADE</b> 134
<b>ACREAGE</b> 165	<b>BUILD TO SUIT</b> 116	<b>100% FINANCING</b> 161	<b>LAKEFRONT</b> 167	<b>NEW PRICE</b> 178	<b>OPEN SUNDAY ___ to ___</b> 133	<b>SPECIAL FINANCING</b> 130	<b>OPEN SUNDAY 2 to 4</b> 182
<b>___ ACRES</b> 125	<b>BY APPOINTMENT ONLY</b> 153	<b>FOR LEASE</b> 110	<b>LAND FOR SALE</b> 155	<b>RESERVED</b> 166	<b>OFFICE</b> 115	<b>SALE OR LEASE</b> 142	<b>OPEN</b> 143
<b>APARTMENT FOR RENT</b> 119	<b>COMMERCIAL</b> 135	<b>FOR RENT</b> 109	<b>LOOK...I'M ON THE WEB www.REALTOR.com</b> 173	<b>SALE PENDING</b> 118	<b>OPEN HOUSE</b> 105	<b>FORECLOSURE</b> 211	<b>SHOWN BY APPOINTMENT</b> 106
<b>Assumable</b> 132	<b>CONDOMINIUM</b> 141	<b>ZONED COMMERCIAL</b> 114	<b>LOT</b> 107	<b>OPEN HOUSE</b> 149	<b>OWNER/BROKER</b> 192	<b>OWNER/AGENT</b> 163	<b>OPEN HOUSE CANCELLED</b> 179
<b>AUCTION</b> 154	<b>CONTRACT PENDING</b> 128	<b>GOLF COURSE</b> 190	<b>LOT ___</b> 177	<b>OWNER FINANCING</b> 117	<b>SOLD</b> 100	<b>SOLD</b> 151	<b>POOL</b> 129
<b>AVAILABLE</b> 171	<b>DUPLEX</b> 138	<b>HOME FOR SALE</b> 191	<b>LOW DOWN PAYMENT</b> 120	<b>SOLD</b> 147	<b>OPEN PLEASE COME IN</b> 139	<b>SHOP</b> 183	<b>WHITE BOARD USE PRESSURE SENSITIVE NUMBERS AVAILABLE FROM LOWEN CALL 800-655-5888 FOR PRICES</b> 146
<b>BASEMENT</b> 169	<b>EXCLUSIVE</b> 101	<b>I'M GORGEOUS INSIDE</b> 174	<b>MULTIPLE LISTING SERVICE MLS</b> 127	<b>SOLD BUT WE HAVE OTHERS</b> 103	<b>SPA</b> 150	<b>FOR SALE</b> 108	<b>OPEN HOUSE TODAY</b> 137
<b>IMMEDIATE POSSESSION</b> 113	<b>NEW HOME</b> 168	<b>OPEN SATURDAY ___ to ___</b> 136	<b>PRICE REDUCED</b> 122	<b>ARROW</b> 102	<b>BANK OWNED</b> 210	<b>POOL/SPA</b> 164	

Minimum order 10 each size rider. May be assorted. Hardware is included. Printed on white powder coated 24 gauge steel on both sides of rider. Rounded corners for your safety. Slots fit all Lowen frames.



12Z131

ITEM		5	10	15	25
12Z131	6 x 24 Bed, Bath and Garage Riders	9.50	9.00	8.25	8.15

Price each.

## AGENT RIDERS



Style A - #34 Black



Style B - #28 Red



Style G - #50 Royal



Style E - #61 Burgundy



12Z803

ITEM		5	10	15	25
12Z150*	6 x 18 24 Ga. Steel Riders	11.50	10.60	8.95	7.95
12Z170	6 x 18 24 Ga. Steel Riders	8.85	8.15	7.70	7.35
12Z180	6 x 24 24 Ga. Steel Riders	9.50	9.00	8.25	8.15
12Z190	6 x 28 24 Ga. Steel Riders	9.95	9.45	8.70	8.60
12Z803	6 x 24 Custom Message Rider	9.50	9.00	8.25	8.15

Price each. Hardware included. Available in colors shown above. \*12Z150 has clipped corners to fit bottom of Round Rod Frame. Shipped FOB Lowen.

## PHOTO RIDERS



ITEM		5	10	15	25
12Z189	6 x 24 24 Ga. Steel Riders	12.45	11.80	9.65	8.70
12Z186	8 x 24 24 Ga. Steel Riders	15.20	14.25	11.15	10.20
12Z189R	6 x 24 Reflective Riders	22.50	22.15	18.10	16.25
12Z186R	8 x 24 Reflective Riders	28.70	27.30	21.75	19.75

Price each. Hardware included. Reflective riders are not available as next business day. Shipped FOB Lowen.

## QR CODE RIDERS

Scanned with a smartphone, QR codes can lead the user to a website, listing page or social media site.



ITEM		5	10	15	25
12Z170QR	6 x 18 24 Ga. Steel	8.95	8.20	7.60	7.30
12Z180QR	6 x 24 24 Ga. Steel	12.45	11.90	9.65	8.75
12Z192QR	8 x 24 24 Ga. Steel	11.55	10.70	9.50	9.45

Price each. Hardware included. Available in polyethylene and corrugated plastic. See [lowensign.com](http://lowensign.com). Shipped FOB Lowen.

# DIRECTIONAL SIGNS

ITEM		5	10	15	25	50	100
<b>Round Rod Frame and Panel Unit</b>							
12Z955-300	18 x 24 Open House	41.25	39.25	36.10	32.55	30.65	28.25
<b>Steel A-Frame and Panel Unit</b>							
12Z954-300	18 x 24 Open House	55.70	52.10	51.95	47.45	46.65	46.30
<b>Poly A-Frame and Sign Panel Unit</b>							
12P952-300	18 x 24 Open House	50.10	45.35	40.95	39.55	36.70	36.20

Price each. A-Frame Units are available in white frame only.  
Shipped assembled FOB Lowen. Also available in Home For Sale, Model Home, and New Home.

ITEM		5	10	15	25	50	100
<b>4 MM Corrugated Plastic House and Arrow Panels</b>							
12C853	18 x 24 Custom House	19.40	16.00	14.15	11.65	10.20	9.15
12C852	18 x 24 Custom Arrow	19.65	16.30	14.50	12.00	10.45	9.45
12C853-300	18 x 24 House - OH	19.40	16.00	14.15	11.65	10.20	9.15
12C853-304	18 x 24 House - HFS	19.40	16.00	14.15	11.65	10.20	9.15
12C852-300	18 x 24 Arrow - OH	19.65	16.30	14.50	12.00	10.45	9.45
12C852-304	18 x 24 Arrow - HFS	19.65	16.30	14.50	12.00	10.45	9.45
12-687	H-Frame Wire Stake Only	3.70					

Price each. Corrugated plastic panels have vertical corrugations. Panels fit H-Frame Wire Stake.  
Shipped FOB Lowen.

ITEM		5	10	15	25	50	100
<b>T-Stake and Panel Unit</b>							
12Z951-300	9 x 24 Open House	26.90	21.20	19.30	16.25	14.90	13.60
12Z951-304	9 x 24 Home For Sale	26.90	21.20	19.30	16.25	14.90	13.60
12Z951-306	9 x 24 For Sale	26.90	21.20	19.30	16.25	14.90	13.60

Price each. Unit includes angle iron stake, panel, and hardware. No extra charge for imprint.  
Also available in New Home, Model Home, For Sale Lot \_\_\_\_, and Land For Sale. Shipped unassembled FOB Lowen.

ITEM		5	10	15	25	50	100
<b>Custom T-Stake and Panel Unit</b>							
12Z910	9 x 24	29.80	23.35	20.95	17.60	14.90	13.60
12Z912	12 x 24	33.25	27.00	24.25	20.10	16.85	15.40

Price each. Available with black or white stake. Shipped unassembled FOB Lowen.

ITEM		2	5	10	15	25	50	100
<b>Custom A-Frame and Panel Unit</b>								
12Z970	*18 x 24 24 Ga. Steel	58.00	51.60	50.70	50.50	47.45	46.65	46.30
12P972	**18 x 24 .050 Poly Lite	68.20	50.10	45.35	40.95	39.55	36.70	36.20

Price each. \*Available in black or white frames. \*\*Available in white frame only.  
Shipped assembled, FOB Lowen.



18 X 24 Round Rod Unit

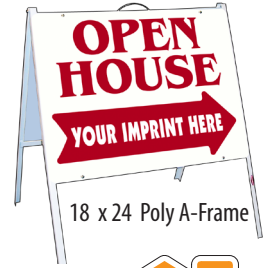

18 x 24 Poly A-Frame



18 x 24 Custom Arrow



18 x 24 Custom House



18 x 24 Stock Arrows and House Shape Panels



Take advantage of cut-to-shape signs!  
To choose custom shapes call 800-545-5505.



9 x 24 Stock T-Stake Unit Panels



9 x 24 T-Stake Unit



12 x 24 T-Stake Unit



18 x 24 Steel A-Frame

# ALTERNATIVE SIGNAGE

## FEATHER FLAGS

ITEM	1	3	5	10
Standard	75.00	62.50	59.75	59.00
Custom	97.80	78.45	74.25	73.55

Price each. Standard flags ship in 3 days. Custom flags ship in 3 weeks.

These full-color flags stay open without a breeze so your custom message is always visible. On windy days, they flutter and swing freely on a rotating base. The pole is easy to assemble and install. You can customize the design of your flag or let one of our experienced Sign Artists create a design for you.



## FULL COLOR BANNERS



All banners are printed with non-fade ink on high-quality vinyl. Submit artwork or work with one of our experienced Sign Artists to customize your message. We can produce any size banner you need! Contact us for a quote on custom sizes.

ITEM		Each
12-265	3' x 6'	83.45
12-266	3' x 10'	85.55
12-270	4' x 8'	87.05

Price each. More sizes available on web. Shipped FOB Lowen.

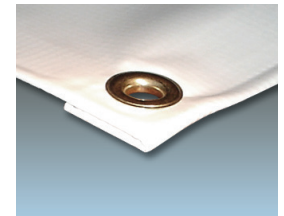

## MAGNETIC SIGNS

**Warning:** Car magnets should not be left on vehicles overnight. Prolonged contact between the magnetic vinyl and the vehicle can result in damage to the vehicle finish.

ITEM		2	4	10	24	50
12-536	10 x 16	33.30	21.05	14.40	11.80	11.15
12-538	12 x 18	35.15	23.45	16.55	13.80	13.15

Price each. Shipped FOB Lowen. Digital printing includes a laminate.



## KWIK-CALS

Kwik-Cals can be used for changing phone numbers on yard signs. You may also use them to add your name to an open house sign. Just peel off the backing and press on any clean dry surface.

ITEM		25	50	100
12V736-100	1-100 Sq. In.	5.30	3.50	2.25
12V736-200	101-200 Sq. In.	5.85	4.00	3.05

Price each. Shipped FOB Lowen.



## PLASTIC YARDBOX

Yard Box allows clients 24-hour access to property information and accommodates 8 1/2" x 11" sheets. Includes business card holder and brackets for attaching to Premier Post.

ITEM		2	12	18	24+
12P510P	YARD BOX	26.65	18.10	17.70	17.40
12W683	YARD BOX STAKE	9.65 each for 5			

Price each. Shipped FOB Lowen. Includes bracket and hardware for frame, stake, or post. See website for each model.



## POPULAR OPEN HOUSE ITEM!



EASILY SLIPS  
ON AND OFF!

### Your Design Here

To Fit

24x18 and 28x18  
Angle Iron Frames  
w/Two Rider Inserts

12-800

### Your Design Here

To Fit

24x24, 25x24, and 22x24  
Angle Iron Frames  
w/Two Rider Inserts  
30x24 Angle Iron Unit

12-802

### Your Design Here

To Fit

20x28 Angle Iron Frame  
w/Two Rider Inserts  
20x28 and 18x30  
Angle Iron Units  
20x28 Classic Unit

12-804

### Your Design Here

To Fit

24x18 Angle Iron Unit  
24x18 Classic Unit

12-801

### Your Design Here

To Fit

18x24 Angle Iron Frame  
w/Two Rider Inserts  
24x24, 25x24,  
22x24, and 18x24  
Angle Iron Units  
24x24 and 18x24  
Classic Units

12-803

### Your Design Here

To Fit

24x30 and 20x30  
Angle Iron Units  
18x30 Classic Unit

12-805

## YARD SIGN SLEEVES

These Sign Sleeves are a quick way to change the message of your signs for your next open house. The Sleeve is sewn out of heavy duty banner material and the bottom corners include metal grommets to secure your Sign Sleeve on windy days. Customize the Sign Sleeve with any design you can think of, printed in full-color with non-fade ink!

ITEM		5	10	15	25	50
12-800	22" wide sleeves	40.40	37.20	36.35	35.60	34.95
12-801	22" wide sleeves	35.95	33.30	32.40	31.60	31.00
12-802	28" wide sleeves	40.30	36.80	36.15	35.35	34.75
12-803	28" wide sleeves	33.95	30.80	29.70	29.10	28.40
12-804	32" wide sleeves	36.70	34.30	33.50	32.75	32.20
12-805	32" wide sleeves	37.65	35.30	34.15	33.55	33.00

Price each. Shipped FOB Lowen.

# COMMERCIAL SIGNS



## COMMERCIAL SIGNS

ITEM		1	3	5	10	15	25
<b>10mm Corrugated Plastic Signs</b>							
12C411	32 x 48 Panel - Single Faced	71.25	43.40	36.95	31.15	29.05	27.30
12C811	32 x 48 Panel - Double Faced	82.00	55.30	46.20	41.00	38.85	37.10
12C412	48 x 48 Panel - Single Faced	65.80	48.55	43.70	40.75	39.70	38.75
12C812	48 x 48 Panel - Double Faced	78.15	62.60	57.55	55.10	53.65	52.60
12C414	48 x 96 Panel - Single Faced	110.50	79.85	74.30	71.80	70.45	69.30
12C814	48 x 96 Panel - Double Faced	135.40	106.40	100.65	98.30	97.15	96.20
12C499	12 x 48 Single Faced	-	25.65	22.00	19.85	16.45	14.30
12C899	12 X 48 Double Faced	-	33.00	29.90	29.10	22.60	19.55

Price each. Shipped FOB, Lowen.

ITEM		3	5	10	15	25
<b>24 Gauge Powder Coated Steel Sign Panels.</b>						
Comes with 4 corner holes and 2 side holes for easier installation.						
12Z483	48 x 48 Panel - Single Faced	58.75	53.70	51.35	49.90	48.95
12Z883	48 x 48 Panel - Double Faced	71.95	66.55	65.15	63.85	62.80

Price each. Shipped FOB, Lowen.

ITEM		1	3	5	10	15	25
<b>24 Gauge Steel Angle Iron Unit</b>							
This durable powder coated 72" frame comes assembled with our 24 gauge double faced powder coated steel panel.							
12Z998	48 x 48 Gibraltar Unit	168.30	147.75	140.50	140.00	138.50	137.30
12-633	48 x 48 Gibraltar Frame Only	73.50	63.20	61.60	61.55	61.35	61.00

Price each. Shipped FOB, Lowen.

ITEM		1	3	5	10	15	25
<b>24 Gauge Steel Angle Iron with Rider Insert Unit</b>							
This commercial unit stands a commanding 96" tall! It accommodates two 6 x 24 message riders with slip-in holders.							
12Z936	48 x 48 Thor Unit	-	209.50	202.65	197.55	196.00	194.70
12-649	48 x 48 Thor Frame Only	98.30	89.15	87.30	85.95	85.75	85.40

Price each. Riders sold separately. Shipped FOB, Lowen.

# COMMERCIAL SIGNS

ITEM		1	2	3	5	10	15	25
------	--	---	---	---	---	----	----	----

## 3mm Aluminum Composite Panels

Painted aluminum over a solid plastic core. Exhibits professional semi-gloss appearance.

12L480	6 x 36 - Single Faced	43.90	-	18.95	14.30	10.70	9.70	8.65
12L880	6 x 36 - Double Faced	44.30	-	21.05	15.80	12.55	11.60	10.60
12L482	6 x 48 - Single Faced	36.25	-	15.75	12.30	10.30	9.90	9.50
12L882	6 x 48 - Double Faced	45.70	-	21.90	17.60	14.40	13.55	12.00
12L400	12 x 48 - Single Faced	40.95	-	20.85	18.00	15.35	14.90	14.10
12L800	12 x 48 - Double Faced	52.10	-	29.10	24.45	20.50	19.25	18.05
12L402	24 x 36 - Single Faced	63.85	42.85	37.75	32.70	28.60	27.40	26.05
12L408	24 x 48 - Single Faced	46.20	32.55	28.05	24.95	22.50	22.05	21.65
12L410	36 x 48 - Single Faced	63.65	54.45	53.25	50.20	48.00	46.95	46.15
12L810	36 x 48 - Double Faced	72.35	65.95	63.70	59.45	57.10	56.25	55.55
12L411	48 x 36 - Single Faced	63.65	54.45	53.25	50.20	48.10	46.95	46.15
12L811	48 x 36 - Double Faced	72.35	65.95	63.70	59.45	57.10	56.25	55.55
12L412	48 x 48 Panel - Single Faced	75.30	62.05	60.45	57.10	55.25	54.00	53.10
12L812	48 x 48 Panel - Double Faced	87.75	78.60	72.80	69.05	67.45	66.35	65.60
12L475	72 x 48 Panel - Single Faced	148.15	115.70	106.90	99.70	88.60	86.70	85.30
12L495	96 x 48 Panel - Single Faced	123.85	107.20	101.95	98.05	89.35	88.55	87.85
12L895	96 x 48 - Double Faced	137.05	118.00	112.80	107.95	97.90	97.25	96.55
12L496	48 x 96 - Single Faced	123.85	107.20	101.95	98.05	89.35	88.55	87.85
12L896	48 x 96 - Double Faced	137.05	118.00	112.80	107.95	97.90	92.25	96.55

Price each. Shipped FOB, Lowen.

ITEM		1	2	3	5	10	15	25
------	--	---	---	---	---	----	----	----

## 6mm Alupalite Panels

Need a rugged material for your commercial listings? Try our Alupalite panels for an alternative to corrugated plastic.

12U414	48 x 96 Panel - Single Faced	167.95	151.35	146.10	142.25	138.95	138.10	137.20
12U814	48 x 96 Panel - Double Faced	190.05	176.15	170.05	165.50	162.65	161.75	160.80

Price each. Shipped FOB, Lowen.

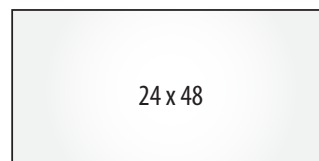
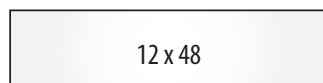
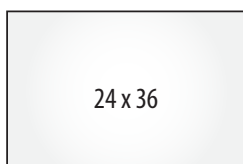
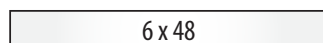
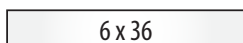
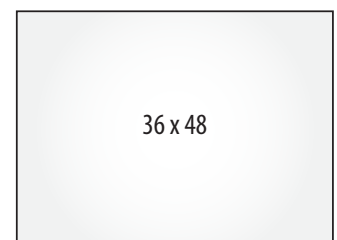
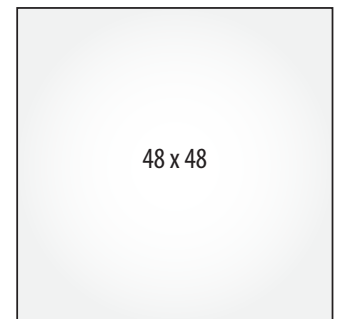
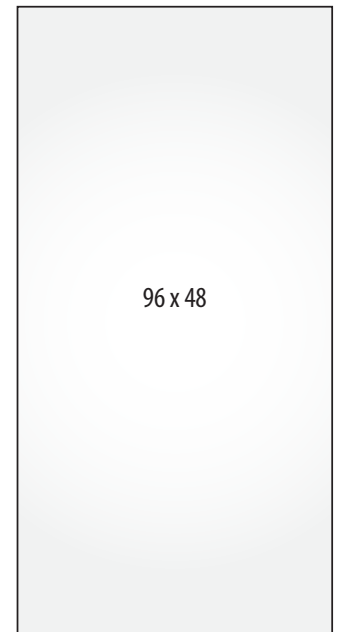
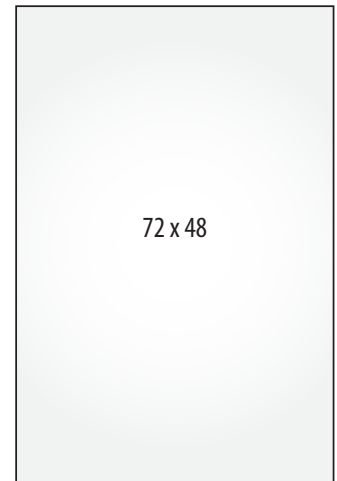

# PANELS

ITEM		5	10	15	25	50	100
<b>24 GA. STEEL PANELS FOR FRAMES AND STAKES - PRINTED BOTH SIDES</b>							
12Z800	6 x 18	8.85	8.15	7.70	7.35	6.50	5.80
12Z804	6 x 28	13.20	11.35	10.20	9.15	7.70	6.80
12Z810	8 x 24	15.20	12.75	11.15	10.20	8.75	7.85
12Z820	9 x 24	17.50	13.75	11.95	10.40	8.65	7.65
12Z832	12 x 18	19.50	15.95	14.15	12.10	10.05	8.95
12Z830	12 x 24	21.00	17.35	15.20	13.05	10.75	9.65
12Z850	18 x 24	25.80	22.15	20.30	16.95	14.35	13.00
12Z852	24 x 18	25.80	22.20	20.25	17.00	14.35	12.95
12Z856	18 x 30	30.50	26.15	23.05	19.95	16.50	15.15
12Z860	20 x 28	33.00	29.35	24.45	21.25	18.0	16.45
12Z862	20 x 30	39.40	35.00	29.95	25.90	21.85	19.95
12Z866	22 x 24	26.15	21.85	19.55	17.00	14.95	13.75
12Z868	27 x 24 Arc Top	35.40	32.05	27.00	23.50	19.95	18.20
12Z869	30 x 24 Arc Top	39.00	34.95	30.05	26.45	22.60	20.75
12Z872	24 x 24	34.30	30.30	25.85	22.30	18.95	17.20
12Z870	24 x 30	37.50	33.70	28.85	25.35	21.55	19.80
12Z876	30 x 24	36.80	33.00	28.20	24.70	20.95	19.25
12Z874	24 x 36	55.75	49.10	42.95	38.20	32.95	30.35
<b>24 GA. STEEL PANELS FOR FRAMES AND STAKES - PRINTED BOTH SIDES - REFLECTIVE</b>							
12Z850R	18 x 24	44.50	39.10	35.50	30.85	28.55	26.00
12Z860R	20 x 28	56.70	51.05	44.05	39.15	36.30	33.15
12Z872R	24 x 24	56.60	50.75	44.50	39.30	36.45	33.25
12Z868R	27 x 24 Arc Top	60.05	54.60	47.20	41.80	38.95	35.60
12Z869R	30 x 24 Arc Top	64.15	57.85	50.65	45.25	42.15	38.75
<b>.040 ALUMINUM PANELS FOR FRAMES AND STAKES - PRINTED BOTH SIDES</b>							
12A850	18 x 24	30.50	23.50	21.10	18.95	16.05	14.25
12A856	18 x 30	36.15	29.20	25.95	23.35	19.80	18.45
12A872	24 x 24	43.15	31.30	27.95	24.70	19.80	19.15
<b>4 MM CORRUGATED PLASTIC PANELS WITH VERTICAL FLUTES- PRINTED BOTH SIDES</b>							
12C820V	9 x 24	13.55	10.65	9.00	7.95	6.70	5.80
12C830V	12 x 24	16.30	13.40	11.65	10.05	8.55	7.50
12C832V	12 x 18	13.50	10.45	9.30	8.10	6.90	6.30
12C850V	18 x 24	19.65	16.30	14.40	10.95	9.00	8.65

ITEM		5	10	15	25	50	100
<b>4 MM CORRUGATED PLASTIC PANELS - CONTINUED</b>							
12C851V	24 x 18	19.65	16.30	14.40	10.95	8.95	8.65
12C860V	20 x 28	24.35	20.65	16.45	12.90	10.70	10.30
12C872V	24 x 24	25.60	22.30	18.60	14.35	11.90	11.50
<b>3MM ALUMINUM COMPOSITE PANEL FOR FRAMES - PRINTED BOTH SIDES</b>							
12L801	6 x 18	12.75	10.80	10.20	9.30	7.40	6.80
12L803	6 x 24	14.60	11.40	10.70	9.35	7.80	7.15
12L804	6 x 28	14.55	12.10	11.10	10.50	8.65	7.70
12L805	8 x 24	15.65	13.45	11.65	10.80	9.50	8.35
12L820	9 x 24	18.60	14.40	12.90	11.25	9.60	8.80
12L830	12 x 24	22.55	18.20	16.25	13.80	11.65	10.45
12L832	12 x 18	20.60	16.90	14.90	12.85	10.80	9.85
12L850	18 x 24	26.95	22.50	20.65	17.35	14.90	13.40
12L852	24 x 18	26.95	22.50	20.65	17.35	14.90	13.40
12L856	18 x 30	32.90	32.05	24.00	21.70	18.80	16.95
12L860	20 x 28	34.35	30.00	25.30	22.35	18.90	16.90
12L861	28 x 20	34.35	30.00	25.30	22.35	18.90	16.90
12L869	30 x 24 Arc Top	40.15	36.55	30.65	27.10	24.50	22.40
12L870	24 x 30	39.10	34.95	29.85	26.15	22.70	21.25
12L872	24 x 24	35.55	32.05	26.65	23.65	20.20	18.60
12L874	24 x 36	57.70	50.50	44.25	39.50	34.35	32.00
12L876	30 x 24	38.55	35.55	29.95	26.25	22.80	21.35
12L878	36 x 36	78.95	74.10	67.35	61.80	57.00	53.30
<b>.090 POLYETHYLENE PANELS FOR FRAMES - PRINTED BOTH SIDES</b>							
12P850	18 X 24	21.90	19.00	16.60	15.40	13.75	13.35
12P852	24 X 18	21.50	19.20	17.30	16.30	14.95	14.60
12P860	20 X 28	27.70	24.90	21.90	20.95	19.25	18.95
12P872	24 X 24	30.95	27.55	23.60	22.10	20.30	19.95

Price each. Hardware is not included.

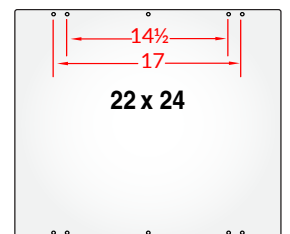
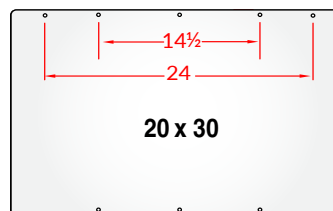



# PANEL HOLE PATTERNS



ITEM		5	10	15	25	50	100
<b>3MM ALUMINUM COMPOSITE HANGING PANELS - PRINTED BOTH SIDES</b>							
12L774H	24 x 36	56.10	50.80	43.90	38.75	33.40	31.15
12L850H	18 x 24	29.05	24.35	22.45	18.50	16.00	14.85
12L856H	18 x 30	33.95	29.05	25.65	22.65	21.65	20.70
12L870H	24 x 30	42.90	38.00	32.80	28.60	24.80	24.45
12L872H	24 x 24	38.20	33.45	28.10	24.90	20.45	18.85
12L873H	30 x 24	42.30	37.40	30.95	28.00	24.20	22.15
<b>24 GA. STEEL HANGING PANELS - PRINTED BOTH SIDES</b>							
12Z850H	18 x 24	27.85	23.30	21.20	17.60	14.80	13.40
12Z856H	18 x 30	32.90	27.85	24.50	21.10	17.40	16.55
12Z872H	24 x 24	36.45	31.95	27.10	23.40	19.75	17.90
12Z873	30 x 24	39.90	35.35	29.40	26.05	21.90	20.05
12Z870H	24 x 30	40.45	35.80	30.40	26.70	22.60	20.80
12Z774H	24 x 36	54.50	47.50	41.35	36.60	31.40	28.95
<b>20 GA. STEEL HANGING PANELS - PRINTED BOTH SIDES</b>							
12Z750H	18 x 24	34.05	29.15	26.50	22.50	19.20	17.45
12Z770H	24 x 30	43.90	39.10	33.40	29.45	25.15	23.00
12Z774H	24 x 36	54.50	47.50	41.35	36.60	31.40	28.95
<b>.063 ALUMINUM HANGING PANELS - PRINTED BOTH SIDES</b>							
12A850H	18 x 24	36.20	31.30	25.65	24.45	20.80	18.20
12A872H	24 x 24	43.00	39.45	32.60	31.25	26.80	23.60
12A873H	30 x 24	51.00	46.10	38.55	37.25	32.20	28.50
<b>.150 POLY HANGING PANELS - PRINTED BOTH SIDES</b>							
12P850H	18 x 24	29.25	24.90	22.35	20.95	19.20	18.70
<b>24 GA. STEEL HANGING PANELS - REFLECTIVE - PRINTED BOTH SIDES</b>							
12Z850RH	18 x 24	46.55	40.15	36.40	31.45	29.10	26.45
12Z872RH	24 x 24	48.40	44.55	39.65	35.15	31.80	29.30
12Z873RH	30 x 24	54.45	50.10	44.70	40.10	36.40	33.55

Price each. Hardware is not included. Top holes of hanging panels protected with brass grommets at no extra cost.

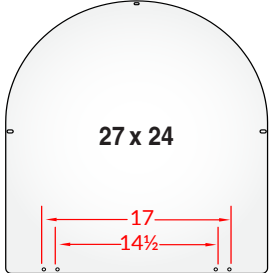
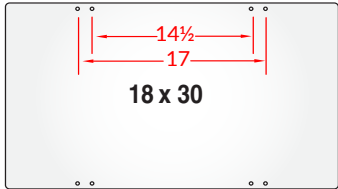
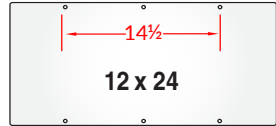
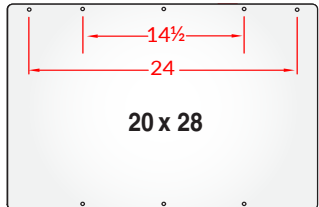
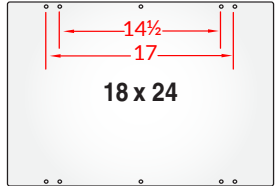
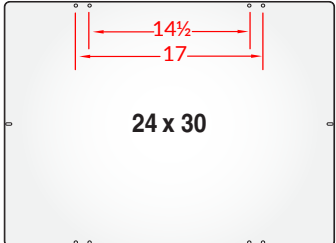
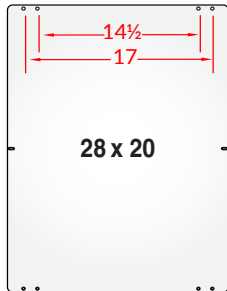
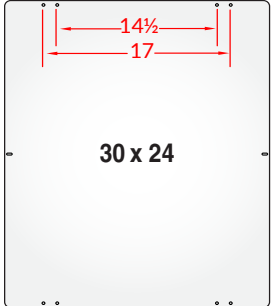
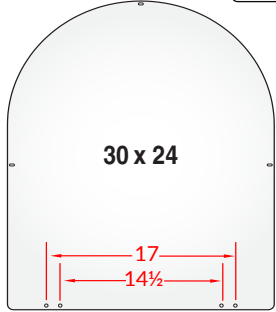
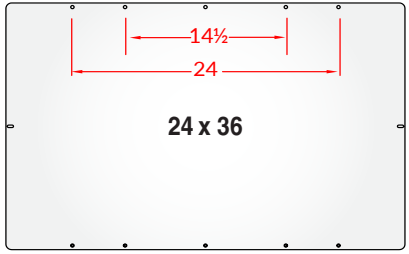
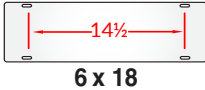
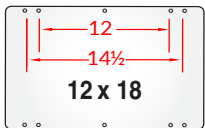
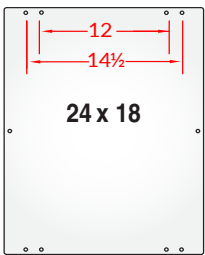
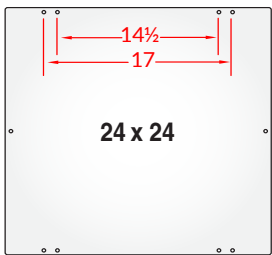
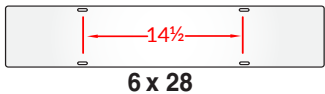
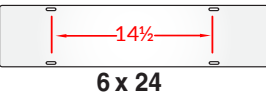
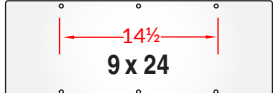
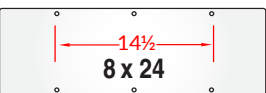





# FRAMES & STAKES

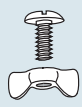

ITEM		1	3	5
12-601	24 x 18 Round Rod Frame	33.30	22.75	20.55
12-602	18 x 24 Round Rod Frame	29.25	18.65	16.50
12-605	28 x 20 Round Rod Frame	29.80	19.25	17.45
12-606	20 x 28 Round Rod Frame	33.05	22.55	20.85
12-608	24 x 24 Round Rod Frame	33.40	22.80	21.10
12-621	24 x 18 Angle Iron Frame	29.75	19.25	17.90
12-622	18 x 24 Angle Iron Frame	30.40	19.95	17.75
12-624	18 x 30 Angle Iron Frame	31.75	21.20	19.50
12-625	28 x 20 Angle Iron Frame	32.55	22.05	20.35
12-626	20 x 28 Angle Iron Frame	31.15	20.65	18.95
12-628	24 x 24 Angle Iron Frame	30.55	20.05	19.05
12-629	24 x 36 Angle Iron Frame	38.55	29.45	27.05
12-630	24 x 30 Angle Iron Frame	32.45	22.50	20.25
12-631	30 x 24 Angle Iron Frame	30.40	20.60	18.70
12-632	30 x 42 Angle Iron Frame	52.40	42.45	40.90
12-643	18 x 24 Angle Iron - 1 Insert	31.85	21.35	19.20
12-642	18 x 24 Angle Iron - 2 Insert	32.35	21.85	19.75
12-646	20 x 28 Angle Iron - 2 Insert	33.55	22.95	21.25
12-648	24 x 24 Angle Iron - 2 Insert	32.75	22.20	20.50

ITEM		1	3	5
12-641	24 x 18 Angle Iron - 2 Insert	32.85	22.35	20.20
12-654	18 x 30 Angle Iron - 1 Insert	-	34.40	31.80
12-653	18 x 30 Angle Iron - 2 Insert	-	39.45	36.90
12-652	27 x 24 Angle Iron Arc - 2 Insert	48.35	37.85	36.20
12W654	30 x 24 White Arc - 2 Insert	46.85	36.90	34.85
12-670	18 x 24 Angle Iron A-Frame	35.25	24.70	22.90
12-687	H-Frame Wire Stake	-	5.20	3.70
12-685	Wire Stake	-	2.00	1.30
12-697	Round Rod H-Stake	-	10.65	8.85
12-693	18 x 24 Tubular Stake	-	29.75	26.90
12-505	18 x 24 White Aluminum Post	76.40	57.40	53.20
12B505	18 x 24 Black Aluminum Post	77.00	57.95	53.80
12-506	19 x 30 White Aluminum Post	77.85	58.85	54.65
12-508	24 x 36 White Aluminum Post	79.15	59.55	56.00
12-684	48" Angle Iron Stake	-	9.70	8.15
12-686	42" Angle Iron Stake	-	13.00	9.95
12-688	44" Angle Iron Stake	-	15.85	12.95
12-636	18 X 24 Slip Angle Frame	-	44.55	41.85

Price each. Hardware is not included. Frames and stakes are black where color is not indicated. Several frames and stakes are also available in white, visit [lowensign.com](http://lowensign.com). Shipped FOB Lowen.

## HARDWARE

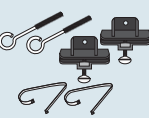
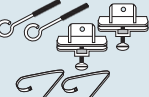
ITEM	Price
 12-700-100 RIDER SETS BAG OF 100	12.40
 12-700-24 RIDER SETS BAG OF 24	4.05
 12-702-100 SIGN PANEL SETS BAG OF 100	8.30
 12-702-25 SIGN PANEL SETS BAG OF 25	3.50
 12-708-20 SAFETY PIN CLIPS BAG OF 20	7.95

ITEM	Price
 12-729B ALUMINUM POST HARDWARE KIT - BLACK	5.10
 12-729W ALUMINUM POST HARDWARE KIT - WHITE	5.10
 12-733 PLASTIC EXTENSION PINS PAIR	2.30

Shipped FOB Lowen.

# FRAMES & STAKES

## Angle Iron with Rider Insert Frames

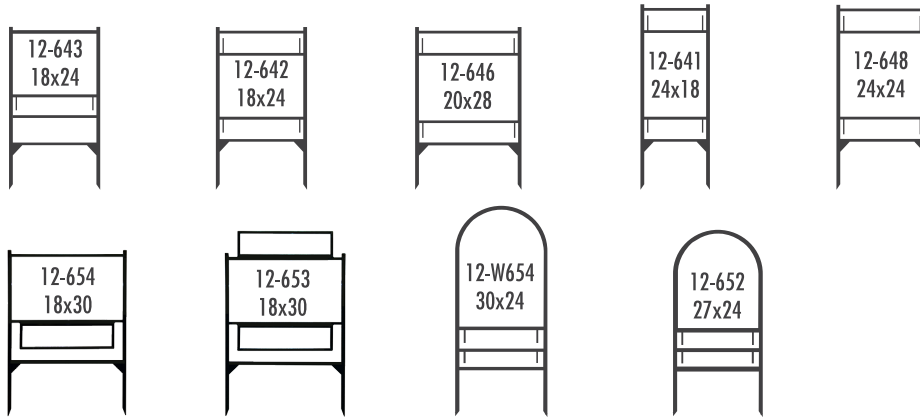

## Angle Iron Frames

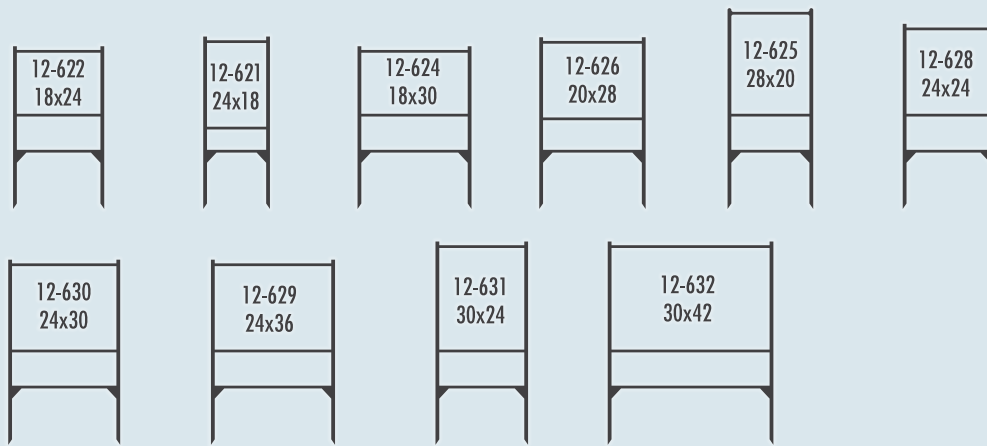

## Round Rod Frames

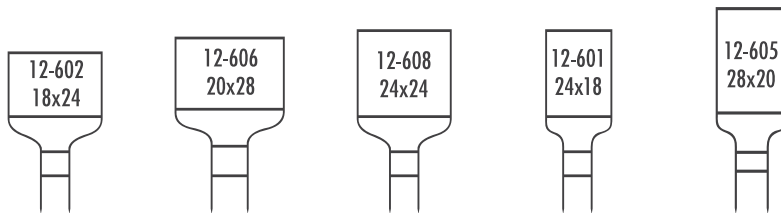

## Aluminum Posts

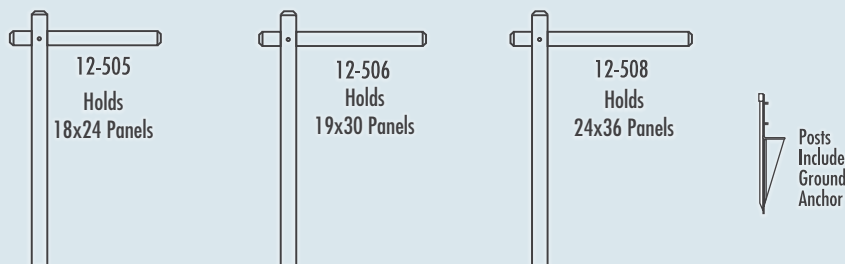

## Other Stakes and Frames



"Very impressed! Wow!  
Wow! Not even a week and  
I got a really NICE product.  
Thank you!" - Haniya N.

We pride ourselves on personal and professional customer service. A real person answers the phone each time you call. No automated voice systems! An experienced Customer Service Representative keeps track of your order from start-to-finish to insure everything goes right.

No matter where you call home,  
We'll help you sell homes.



Centrally located  
for faster, more  
convenient shipping.



Professional Signage for Real Estate Professionals



Our production time is the fastest in the industry.  
Your order is produced and on-the-way in just 3 days.

All specifications in this catalog supersede previous catalogs and are subject to change without notice. Please go to [www.lowensign.com](http://www.lowensign.com) for current prices and information. We reserve the right to correct typographical errors. The design and contents of this catalog are copyrighted.

You can find us on social media.  
Follow and Like us today!

CALL 800-545-5505 FAX 800-846-4466 LOWENSIGN.COM

