



OUR 3 DAY PRODUCTION TIME IS THE FASTEST IN THE INDUSTRY!

800.545.5505  
LOWENSIGN.COM



SIGN COMPANY

A DIVISION OF LOWEN CORPORATION



## WHAT YOU GET WHEN YOU WORK WITH LOWEN SIGN COMPANY

We know you're busy. That's why Lowen Sign Company is continuously improving the products and services we provide. Order tracking and management tools at [lowensign.com](http://lowensign.com) make it easy to reorder your yard signs and see what orders are on the way. You can even order signage on-the-go with your mobile device!

This hassle free experience is made even better with the fastest production time in the industry. Once you approve your order, signs are produced in just 3 days. They're then shipped promptly with tracking info provided in your [lowensign.com](http://lowensign.com) account.

**"I HAD CALLED ANOTHER COMPANY FOR A QUOTE BEFORE ORDERING FROM LOWEN. THEY WERE HIGHER IN PRICE AND WANTED TO CHARGE ME MORE BECAUSE I WAS CONCERNED ABOUT THE DELIVERY TIME. I WENT ONLINE AT LOWEN AND BEFORE I PUSHED SEND, I CALLED IN AND GOT A CUSTOMER SERVICE REPRESENTATIVE. SHE WALKED ME THROUGH THINGS AND HELPED TO EXPEDITE MY ORDER WHICH WENT OUT IN RECORD TIME."**

**- SUSAN FIKE**



## SUPERIOR MATERIALS

Advanced printing technology ensures a beautiful sign with a message that will last. All steel panels and frames are manufactured by us and are sealed with a powder coat for durability and longevity. We pride ourselves on overseeing the details of our products from start to finish.



## FAST PRODUCTION TIME

**Our 3 day production time is the fastest in the industry!**

We've advanced our art systems, invested in the newest printing technology, and expanded our work force to achieve a 3 Day Production Program. This program ensures sign delivery in record time. Your order is produced and ready to ship just 3 days after order approval.



## CUSTOMER SERVICE

When you call Lowen, a real person answers the phone every time. There's no automated voice system here. Our friendly and knowledgeable representatives make sure you get the perfect signage for your professional real estate needs.



## WEBSITE FEATURES

We've worked hard to make our website mobile friendly. That means it's easy to order signs on-the-go from your phone or tablet. The biggest advantage to our website are the account features such as Order History and Shipment Tracking.



## CENTRALLY LOCATED

All of our signage and frames are made in the U.S.A.! We manufacture our products from raw materials at our headquarters in Hutchinson, Kansas. Because of our central location in the heart of America, we have the advantage of fast delivery to anywhere in the country.

# LOWESIGN.COM

Leave the cluttered, confusing, online ordering experience behind.



1

ACCESS FROM YOUR TABLET OR MOBILE FOR ON-THE-GO ORDERING.

2

ORDER HISTORY FOR ONE CLICK REORDERING OF YOUR FAVORITE PRODUCTS.

3

KNOW WHEN TO EXPECT YOUR ORDER WITH SHIPMENT TRACKING.

4

EASILY CUSTOMIZE YOUR REAL ESTATE SIGNAGE.

# HANGING PANELS & POSTS



30x24 Hanging Panel-  
Post and Rider  
Sold Separately



18x30 Hanging Panel



30x24 Hanging Panel

## 24 GA. STEEL HANGING PANELS

ITEM		3	5	10	15	25	50
18Z864	18 x 30 Steel Panel - No Photo	31.05	24.90	19.90	17.90	16.80	16.20
18Z863	18 x 30 Steel Panel With Photo	31.05	24.90	19.90	17.90	16.80	16.20
18Z862AH	30 x 24 Steel Panel - No Photo	36.20	30.00	25.00	21.35	20.70	20.30

## .150 POLYETHYLENE HANGING PANELS

ITEM		3	5	10	15	25	50
18P864	18 x 30 .150 Poly Panel - No Photo	37.70	30.40	25.50	24.70	24.00	23.80
18P863	18 x 30 .150 Poly Panel With Photo	37.70	30.40	25.50	24.70	24.00	23.80

## STEEL REFLECTIVE HANGING PANELS

ITEM		3	5	10	15	25	50
18Z864R	18 x 30 Reflective Panel - No Photo	49.10	41.10	33.80	30.85	29.70	29.30
18Z863R	18 x 30 Reflective Panel With Photo	49.10	41.10	33.80	30.85	29.70	29.30
18Z862AHR	30 x 24 Steel Panel - No Photo	53.90	46.00	37.90	34.40	34.35	34.15

## .063 ALUMINUM HANGING PANELS

ITEM		3	5	10	15	25	50
18A864	18 x 30 Aluminum Panel - No Photo	37.35	30.95	27.35	24.95	24.00	23.25
18A863	18 x 30 Aluminum Panel With Photo	39.35	30.95	27.35	24.95	24.00	23.25
18A861H	30 x 24 Aluminum Panel - No Photo	41.65	37.05	31.85	27.65	27.30	26.70

## ALUMINUM COMPOSITE HANGING PANELS - NEW!

ITEM		3	5	10	15	25	50
18L864	18 x 30 Aluminum Composite Panel	36.85	33.15	28.95	26.35	25.60	25.40
18L861H	30 x 24 Aluminum Composite Panel	40.45	35.95	30.75	27.40	27.05	26.45
18L863R	18 x 30 Aluminum Composite Reflective	56.20	49.90	44.15	40.65	39.45	39.25
18L862AHR	30 x 24 Aluminum Composite Reflective	63.15	59.40	52.55	45.40	44.65	44.00

## ALUMINUM POSTS

ITEM		1	3	5
18-505	Aluminum Post 18 x 30	73.15	55.30	51.45
12-505	Aluminum Post 30 x 24	76.30	57.35	53.20

### Additional Information On This Page

- Price each.
- Price includes two brass grommets on all Hanging Panels.
- On 18 x 30 and 30 x 24 panels, holes are punched on 17" centers top and 14 1/2" centers bottom.
- Cross arm for 18 x 30 Premier Post is 42" in length.
- For 30 x 24 Cross arm is 38" in length.
- Shipped FOB, Lowen.

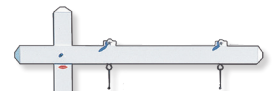

Post includes hardware, rider clips and ground anchor

Item #12-713  
Extra Ground Anchor  
\$16.05 each

Item #18-714  
Inside Office Display Stand  
\$26.85 each



# SIGN UNITS - FRAME & PANEL SOLD TOGETHER

## ANGLE IRON UNITS

ITEM		3	5	10	15	25	50
18Z922	18 x 24 24ga. Steel Unit	44.85	37.45	34.10	33.40	32.10	32.05
18Z922R	18 x 24 Steel Reflective Unit	58.90	49.80	46.15	45.15	44.05	43.25
18A922	18 x 24 Aluminum Unit	47.40	39.20	35.70	34.50	34.05	33.20
18A922R	18 x 24 Aluminum Revlective Unit	55.65	52.15	47.90	46.65	45.50	44.60
18Z924	18 x 30 24 ga. Steel Unit	50.20	42.65	38.05	36.65	35.30	35.00
18Z924R	18 x 30 Steel Reflective Unit	63.40	59.95	57.65	56.65	56.50	55.80
18P924	18 x 30 .090 Poly Unit	52.25	46.50	42.35	41.75	41.40	40.45
18A924	18 X 30 Aluminum Unit	51.40	43.85	39.20	37.85	36.45	36.10
18A924R	18 x 30 Aluminum Reflective Unit	66.00	65.05	63.70	62.10	61.00	59.90
18Z937A	30 x 24 24 ga. Steel Unit	53.30	45.90	41.35	39.45	38.15	38.00
18A937AR	30 x 24 Steel Reflective Unit	74.45	66.65	61.85	59.20	57.75	57.90

Price each. Shipped assembled, FOB Lowen. 18-624 - 18 x 30 Angle Iron Frame only \$18.00 (minimum order 5).

## ANGLE IRON PHOTO UNITS

ITEM		3	5	10	15	25	50
18Z936	18 x 30 24 ga. Steel Photo Unit	50.20	42.65	38.05	36.65	35.30	35.00
18Z936R	18 x 30 Steel Reflective Photo Unit	63.40	59.95	57.65	56.65	56.50	55.80
18P924P	18 x 30 Poly Photo Unit	52.35	46.60	42.45	41.85	41.50	40.55
18A936	18 x 30 Aluminum Photo Unit	51.40	43.85	39.20	37.85	36.45	36.10

Price each. Shipped assembled, FOB Lowen. 18-624 - 18 x 30 Angle Iron Frame only \$18.00 (minimum order 5).

## 1 AND 2 RIDER INSERT SIGN/PHOTO UNITS

ITEM		3	5	10	15	25	50
18Z941	18 x 30 Steel 1 Rider Insert Unit	58.05	51.40	43.95	42.30	41.05	40.15
18P938	18 x 30 1 Rider Insert Photo Unit	57.90	51.25	43.80	42.15	40.90	40.00
18Z940	18 x 30 2 Rider Insert Unit	72.40	64.85	56.00	54.10	52.75	51.70
18Z939	18 x 30 2 Rider Insert Photo Unit	72.40	64.85	56.00	54.10	52.75	51.70

Price each. Shipped assembled, FOB Lowen. Riders not included. 12-654 - 18 x 30 Angle Iron Frame only with one rider insert \$31.80 (minimum order 5). 12-653 - 18 x 30 Angle Iron Frame only with two rider inserts \$36.85 (minimum order 5).

## ROUND ROD UNITS / ROUND ROD PHOTO UNITS

ITEM		3	5	10	15	25	50
18Z910	18 x 30 24 ga. Steel Unit	47.70	41.35	39.75	39.20	38.50	37.90
18Z912	18 x 30 24 ga. Steel Photo Unit	47.70	41.35	39.75	39.20	38.50	37.90
18P910	18 x 30 .090 Poly Unit	51.25	45.75	43.90	43.65	43.05	42.55
18Z910R	18 x 30 Steel Reflective Unit	63.00	55.45	52.60	52.10	51.35	50.70
18Z912R	18 x 30 Steel Reflective Photo Unit	63.00	55.45	52.60	52.10	51.35	50.70

Price each. Shipped assembled, FOB Lowen. 18-610 - Round Rod Frame only \$23.50 (minimum order 5).

## REPLACEMENT PANELS ONLY

ITEM		3	5	10	15	25	50
18Z850	18 x 24 24ga. Steel Panel	25.05	19.55	15.80	14.90	13.65	13.35
18Z850R	18 x 24 Steel Reflective Panel	36.50	31.80	26.75	26.45	25.60	25.15
18Z856	18 x 30 24 ga. Steel Panel - No Photo	28.70	23.10	18.75	16.90	15.90	15.35
18Z855	18 x 30 24 ga. Steel Panel With Photo	28.70	23.10	18.75	16.90	15.90	15.35
18Z861	30 x 24 24 ga. Steel Panel - No Photo	33.75	28.85	23.85	20.45	20.00	19.40
18Z861R	30 x 24 24 ga. Steel Reflective	55.60	51.25	44.95	38.85	38.55	37.95

Price each. Shipped FOB Lowen.



Angle Iron Units



Rider Insert Units



18 x 30  
Round Rod Photo Unit

See website for additional panel material choices - [lowensign.com](http://lowensign.com)

# DIRECTIONAL SIGNS

## A-FRAME UNITS

The Poly Lite unit has polyethylene panels fastened to a powder coated steel frame for stability and weighs only 8½ lbs. For a heavy duty unit, our 24 gauge, powder coated steel tent unit weighs 15 lbs. Both units are personalized with office and agent name at no extra charge.

ITEM		3	5	10	15	25	50
18P952-300	18 x 24 Open House Poly Lite Tent Unit						
18P952P-300	18 x 24 Open House Poly Lite Photo Unit	63.05	46.90	42.25	38.75	37.35	37.15

Price each. Shipped FOB Lowen.

ITEM		3	5	10	15	25	50
18Z970-300	18 x 24 Open House Steel Tent Unit						
18Z970P-300	18 x 24 Open House Photo Steel Unit	57.50	51.45	58.25	48.05	47.20	46.45

Price each. Shipped FOB Lowen.

ITEM		1	3	5	10
18Z958-300	24 x 18 Open House Steel Tent Unit	74.00	64.30	56.50	55.10
18P958-300	24 x 18 Open House Poly Lite Tent Unit	82.70	66.65	59.10	57.65

Price each. Shipped FOB Lowen.

## H-STAKE SIGN UNITS

The 10mm corrugated plastic panel is practically indestructible. The unit is 42 inches tall, requires no hardware and can be assembled in seconds. Message riders conveniently attach to the top of the panel. The stake is constructed with 5/16" round rod steel and 3/4" welded steel strap braces. The H-Stake Sign makes a great directional or economical yard sign!



ITEM		3	5	10	15	25	50
18C900	18 x 30 H-Stake Sign Unit	36.15	30.90	27.15	26.35	25.10	24.35
18C854	18 x 30 Panel Only	32.55	26.70	23.15	21.95	20.55	20.45
18-697	H-Stake Only	9.95	8.30				

Price each. Shipped FOB Lowen.

## ROUND ROD DIRECTIONAL UNITS

These powder coated, 24 gauge steel sign panels are printed with our non-fade inks. The Round Rod Frame is powder coated black and includes a strong footpush. A unit includes a sign panel and arrives fully assembled.

ITEM		3	5	10	15	25	50
18Z955-300	18 x 24 Open House Unit						
18Z955-306	18 x 24 For Sale Unit	38.15	31.95	30.75	28.90	28.10	27.65
18Z320-300	18 x 24 Open House Panel						
18Z320-306	18 x 24 For Sale Panel	25.10	19.55	15.80	14.90	13.70	13.35
18-602	18 x 24 Frame Only	18.00	16.10				

Price each. Shipped FOB Lowen.



18x24 Steel Tent Unit



24x18 Tent Unit

**NEW!**



Round Rod Units

# DIRECTIONAL SIGNS

## CORRUGATED PLASTIC SIGNS

Use these lightweight, moisture proof, 4mm corrugated plastic signs where cost is a factor. They fit our Wire Stake (sold separately). Signs are available with vertical flutes only and are printed on both sides. Personalized at no extra charge.

ITEM		3	5	10	15	25	50	100
18C320-300	18 x 24 Open House Sign							
18C320-306	18 x 24 For Sale Sign	24.40	17.95	13.80	11.85	10.60	9.95	9.55
18C852-300	18 x 24 Open House (Arrow)							
18C852-306	18 x 24 For Sale (Arrow)	23.45	18.00	13.85	11.95	10.75	10.15	9.75
18C853-303	18 x 24 Open (House)							
18C853-306	18 x 24 For Sale (House)	23.25	17.80	13.65	11.85	10.65	9.95	9.60
18C400-306	18 x 24 For Sale Sign							
18C400-300	18 x 24 Open House Sign	24.40	17.95	13.80	11.85	10.60	9.95	9.55
18C600-300	9.5 x 23 Open House Arrow							
18C600-306	9.5 x 23 For Sale Arrow	27.55	19.40	14.15	13.40	11.35	10.20	9.60
18C605-300	21.5 x 12 Open House Arrow							
18C605-306	21.5 x 12 For Sale Arrow	21.25	15.60	11.65	10.90	9.50	8.45	8.10
18C610-300	14 x 22 Open House Panel							
18C610-306	14 x 22 For Sale Panel	33.40	24.00	17.40	15.75	14.05	13.05	12.40
18C615-300	12 x 23 Open House Panel							
18C615-306	12 x 23 For Sale Panel	27.60	20.35	15.15	14.15	12.60	11.05	10.60
18C620-300-RC	18 x 12 Open House Panel							
18C620-306-RC	18 x 12 For Sale Panel	27.20	19.15	13.35	11.25	9.35	8.40	7.95
18-687	Wire Stake Only	5.20	3.70					

Price each. Shipped FOB Lowen.  
To comply with your local or state sign regulations please provide us with those guidelines when ordering.  
May require custom pricing.

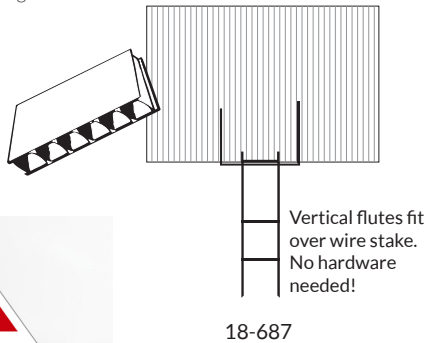

# MESSAGE RIDERS

ALL MESSAGE RIDERS ARE AVAILABLE IN THESE THREE SIZES

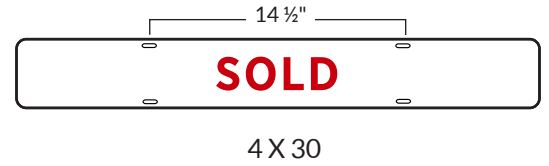
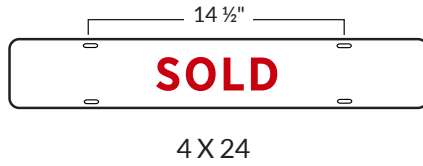

**SOLD**    **OPEN HOUSE**    **FOR LEASE**  
**WILL BUILD TO SUIT**    **5 BEDROOMS**    **PRICE REDUCED**  
**CONTRACT PENDING**    **POOL**    **WATERFRONT**  
**ACREAGE**    **SHOWN BY APPOINTMENT**    **LAKEFRONT**  
**NEW PRICE**    **COMING SOON**    **HABLA ESPAÑOL**  
**I'M GORGEOUS INSIDE**    **JUST LISTED**    **← OPEN HOUSE**

**TOO LATE**    **OPEN SUNDAY**

**MIRACLE HOME**

Riders are printed on white powder coated 24 gauge steel and feature rounded corners for your safety. Slots are punched on 14 1/2 centers top and bottom and hardware is included.

ITEM		3	Min. 10
18Z185	6 x 24 Message Riders	-	5.75
18Z165	4 x 24 Message Riders	-	5.95
18Z166	4 x 30 Message Riders	-	6.35
18Z181	6 x 24 Miracle Home Rider	14.70	9.00
18Z182	6 x 24 Miracle Home Rider with Space for Local Hospital Label	14.70	9.00

**YOUR COPY HERE**

## CUSTOM COPY RIDERS

ITEM		3	5	10	15	25
18Z180	6 x 24 Custom	15.30	9.95	9.40	8.60	8.50
18Z160	4 x 24 Custom	14.20	8.75	8.15	7.65	7.30
18Z167	4 x 30 Custom	16.10	11.05	9.60	9.45	9.00

Price each.  
Place these riders at the top of your post/unit.  
Shipped FOB, Lowen.

## WHAT IS A SIGN RIDER AND WHY DO I NEED ONE?

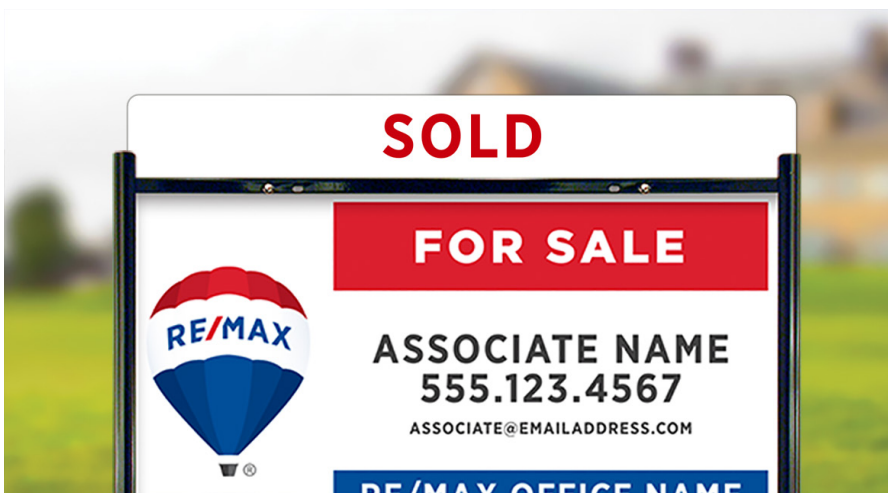

Put simply, a sign rider is a small, rectangular sign panel that can be easily added to a larger yard sign unit to provide the buyer with more information.

From **Just Listed** to **Sold**, there is plenty of information you may want to communicate to buyers over the life of a listing. With our **Next Day Rider Program** you can change your message quickly and conveniently. Your riders are produced in less than 24 hours from order approval and then shipped to you.



# PERSONAL PROMOTION ITEMS

## LICENSE PLATES

Advertise while you drive with custom license plates. Attractive, standard-size license plates fit all foreign and domestic automobiles. These license plates are made from powder coated 24 gauge steel. Printed on one side with non-fade ink.



ITEM		3	5	10	15	25
18Z403	6 x 12 License Plates	10.55	6.80	4.90	4.65	4.10

Price each. Shipped FOB, Lowen.



3' x 6'



4' x 8'

## FULL COLOR BANNERS

These full-color, customizable, vinyl banners can be used for your commercial real estate properties, real estate offices or company events. Our vinyl banners are digitally printed with non-fade ink on high-quality vinyl to produce a pristine image.

Call 800-545-5505 for a quote on custom sizes.

ITEM		EACH
12-265	3' x 6' Full Color Banner w/ Grommets and Hems	83.45
12-270	4' x 8' Full Color Banner w/ Grommets and Hems	87.05

Price each. Shipped FOB, Lowen, with press ready art. Grommets and Hems included.

## MAGNETIC SIGNS

ITEM		2 ALIKE	4	10	24	50
18-534AF	10 x 16 magnetic	33.20	21.00	14.35	11.75	11.10

Price each. Shipped FOB, Lowen.

Warning: Car magnets should not be left on vehicles overnight. Prolonged contact between the magnetic vinyl and the vehicle can result in damage to the vehicle finish.

Transform your personal car into a billboard by using a custom magnetic car sign. These flexible, magnetic, vinyl door signs are very easy to apply and remove. They are digitally printed to include the finest details. Perfect for real estate agents!



## PLASTIC YARDBOX

Yard Box allows clients 24-hour access to property information and accommodates full 8 1/2" x 11" sheets. Includes business card holder and brackets for attaching to Lowen Sign frames.



ITEM		1	3	6	12
18P510G	Fits Angle Iron/ Round Rod	33.00	24.95	23.05	23.00
18P510P	Fits Aluminum Post	33.35	25.30	23.40	23.40

Price each. Shipped FOB, Lowen.



## FEATHER FLAGS

These full-color, 9 foot flags stay open without a breeze so your custom message is always visible. On windy days, they flutter and swing freely on a rotating base. The pole is easy to assemble and install. You can customize the design of your flag or let one of our experienced Sign Artists create a design for you.

ITEM		1	3	5	10
18-282-300	OH Feather Flag	75.00	62.55	59.75	59.00

Price each. Shipped FOB, Lowen.



## FLAG DISPLAY STAND

Display feather flags indoors or outdoors where ground anchors cannot be used with this display stand. Feather flag base has axle to allow flag to rotate freely. \$59.15 each.

# COMMERCIAL SIGNS



48 x 48 Angle Iron Unit



48 x 96 Panel



48 x 48 Angle Iron  
1-Insert Unit  
Riders sold separately.

## 24 GAUGE STEEL ANGLE IRON UNIT

This durable, powder coated, 72" frame comes assembled with our 24 gauge, double-faced steel panel. Makes installation easy!

ITEM #		3	5	10	15	25
18Z998	48 x 48 Angle Iron Unit	147.30	140.00	139.35	137.85	136.65
12-633	48 x 48 Frame Only	62.95	61.45	61.30	61.10	60.75

Price each. Shipped FOB, Lowen.

## 24 GAUGE STEEL SIGN PANELS

These signs can be mounted to 4' x 4' posts.

ITEM #		3	5	10	15	25
18Z483	48 x 48 Panel - Single Faced	58.55	53.55	51.15	49.75	48.75
18Z883	48 x 48 Panel - Double Faced	71.60	66.20	64.65	63.30	62.30

Price each. Shipped FOB, Lowen.

## ALUMINUM COMPOSITE PANELS

Painted aluminum over a solid plastic core.

ITEM #		3	5	10	15	25
18L412	48 x 48 Panel - Single Faced	60.35	56.95	55.00	53.75	52.80
18L812	48 x 48 Panel - Double Faced	72.55	68.80	67.15	66.05	65.35

Price each. Shipped FOB, Lowen.

## 24 GAUGE STEEL ANGLE IRON 1-INSERT UNIT

This commercial Unit stands a commanding 96" tall! It accommodates two 6 x 24 message riders that slip in easily.

ITEM #		3	5	10	15	25
18Z946	48 x 48 1-Insert Unit	208.50	201.70	196.65	195.10	193.80
12-649	48 x 48 Frame Only	83.45	81.75	80.55	80.30	79.95

Price each. Shipped FOB, Lowen.

## 10MM CORRUGATED PLASTIC PANELS

These signs are lightweight, moisture proof and outdoor durable.

ITEM #		3	5	10	15	25
18C412	48 x 48 - Single Faced	48.35	43.55	40.60	39.55	38.55
18C812	48 x 48 - Double Faced	62.45	57.35	54.85	53.35	52.35
18C414	48 x 96 - Single Faced	79.65	74.05	71.55	70.20	69.05
18C814	48 x 96 - Double Faced	106.15	100.35	97.95	96.75	95.80
18C520	12 x 48 Rider	26.20	20.50	16.90	15.85	14.85

Price each. Shipped FOB, Lowen.

## ALUMALITE PANELS

Aluminum composite panel with a corrugated polyallomer core.

ITEM #		3	5	10	15	25
18U414	48 x 96 Panel - Single	145.75	141.95	141.75	140.95	140.00
18U814	48 x 96 Panel - Double	169.60	165.05	162.25	161.35	160.35

Price each. Shipped FOB, Lowen.

# LOWEN PROVIDES MORE

We won't nickel and dime you! While other suppliers have never ending discounts and flash sales, Lowen will always have your products priced as low as possible year round. We don't like fine print and try to work with each individual customer to provide them with the signage they need for the best price.



**WE PROVIDE LASTING QUALITY AT THE BEST PRICE.**  
These features come standard when you order from Lowen.

- **CLEAR COAT** blocks UV rays to protect your image.
- **POWDER COAT** prevents rust and provides a luxurious finish.
- **BRASS GROMMETS** prevent holes from ripping out and protects the sign finish.
- **ROUNDED CORNERS** and edges present a finished look while protecting your safety.
- **FULLY ASSEMBLED** signs allow you to go from box to yard with no extra work.

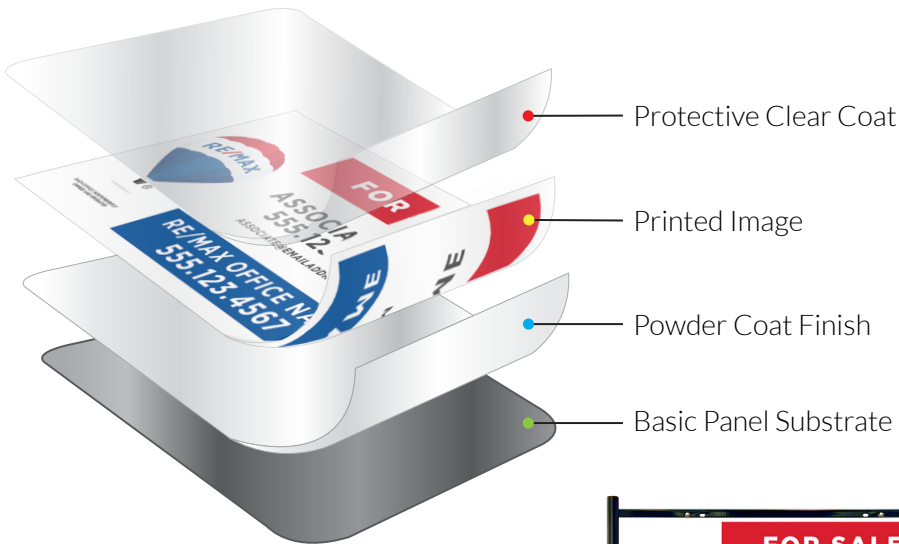

"Very impressed! Wow!  
Wow! Not even a week and  
I got a really NICE product.  
Thank you!" - Haniya N.

We pride ourselves on personal and professional customer service. A real person answers the phone each time you call. No automated voice systems! An experienced Customer Service Representative keeps track of your order from start-to-finish to ensure everything goes right.

No matter where you call home,  
We'll help you sell homes.

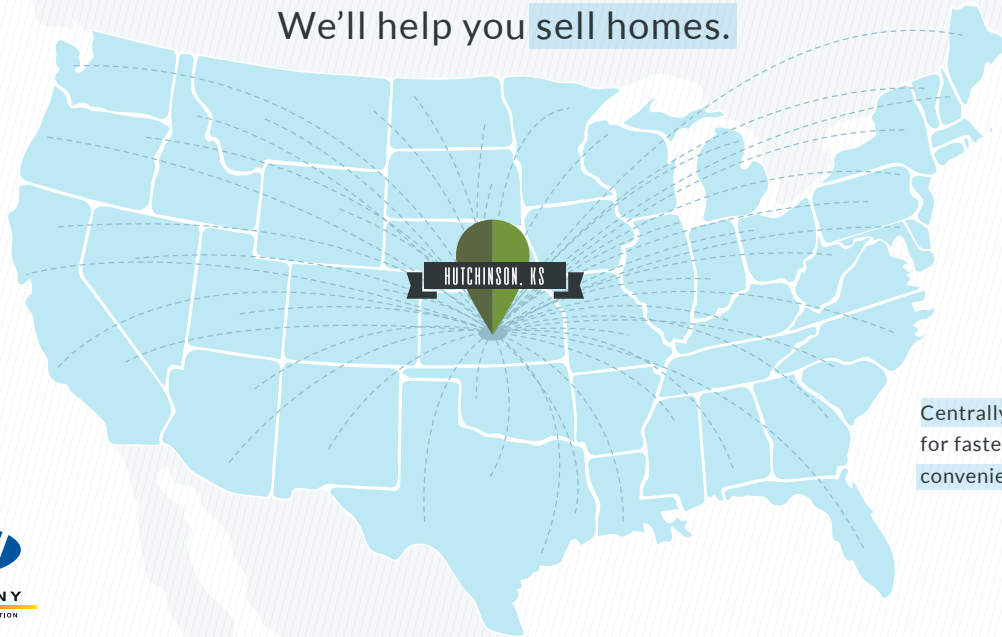

Centrally located  
for faster, more  
convenient shipping.



Professional Signage for Real Estate Professionals



All specifications in this catalog supersede previous catalogs and are subject to change without notice. Please go to [www.lowensign.com](http://www.lowensign.com) for current prices and information. We reserve the right to correct typographical errors. The design and contents of this catalog are copyrighted.

You can find us on social media.  
Follow and Like us today!

CALL 800-545-5505 FAX 800-846-4466 LOWENSIGN.COM

